

The logo consists of a black rectangle with a white stylized eye shape in the center. Inside the eye, the text "PELHAM PICTORIAL SPORTS INSTRUCTION SERIES" is written in white, stacked vertically.

PELHAM  
PICTORIAL  
SPORTS  
INSTRUCTION  
SERIES



**Bill Scull**  
(Senior National Coach, B.G.A.)

**Gliding and  
Soaring**

# Ex Libris

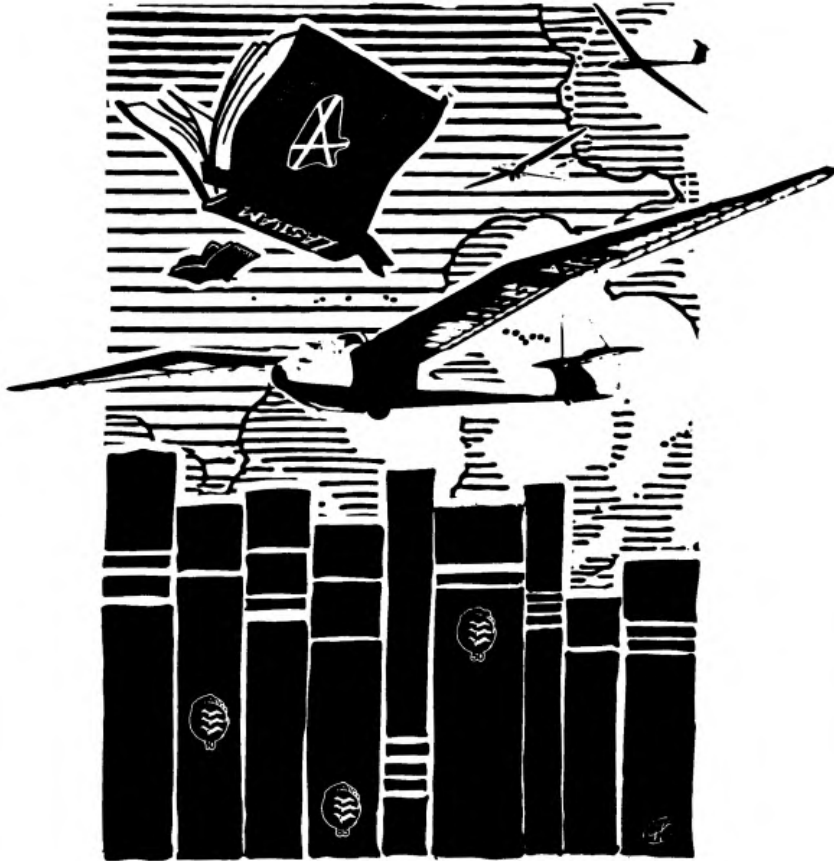

From the Gliding Library of  
**Wally Kahn**

# GLIDING AND SOARING

***Also in the Pelham Pictorial Sports Instruction Series***

John Dawes: Rugby Union

Chester Barnes: Table Tennis

Henry Cooper: Boxing

Bob Wilson: Soccer

Barry Richards: Cricket

Richard Hawkey: Squash Rackets

Ken Adwick: Golf

Jack Karnehm: Understanding Billiards and Snooker

Rachael Heyhoe Flint: Women's Hockey

Paul and Sue Whetnall: Badminton

Denis Watts: Athletics – Jumping and Vaulting

Howard and Rosemary Payne: Athletics – Throwing

Brian Jacks: Judo

Celia Brackenridge: Women's Lacrosse

David Haller: Swimming

# **Pelham Pictorial Sports Instruction Series**

**Bill Scull**

*(Senior National Coach B.G.A.)*

# **GLIDING AND SOARING**



**Pelham Books**

photographs by the author, except  
cover photograph by Lorna Minton, and  
figure 26 by John McGeorge

First published in Great Britain by  
PELHAM BOOKS LTD  
52 Bedford Square  
London WC1B 3EF  
1977

© Bill Scull, 1977

All Rights Reserved. No part of this publication  
may be reproduced, stored in a retrieval system,  
or transmitted, in any form or by any means,  
electronic, mechanical, photocopying, recording  
or otherwise, without the prior permission of the  
Copyright owner

ISBN 0 7207 0934 2

Filmset and printed in Great Britain by  
BAS Printers Limited, Wallop, Hampshire

# Contents

## **Introduction 7**

- 1 A team sport: the first flight **9**
  - 2 Basic skills and co-ordination **15**
  - 3 Judgement and decision making for landing **25**
  - 4 Slow flight **30**
  - 5 The launch **32**
  - 6 After solo: soaring and cross-country techniques **39**
  - 7 The first cross-country flight **46**
  - 8 Achievements **52**
- Appendix: The Development of Gliders **56**
- Glossary **62**
- Further Reading **64**

# Introduction

Have you ever stood on the edge of a cliff watching seagulls floating almost motionless in the wind, and wondered how it must feel? You can experience the sensation by learning to fly, in not an aeroplane, but a glider.

Many people regard gliding as a poor man's means of flying. They cannot conceive that flight without an engine is possible, or that a glider is controllable. They regard it as some form of kite, and how controllable is a kite without a string? You will find that gliders can be landed within feet of the position the pilot chooses, and the sport has an excellent safety record.

Be warned! Once you have started to glide, you may find yourself hooked. The fascination of gliding lies in the mystery and challenge which constantly lies ahead.

The first flight is a tremendous thrill. The sensations and the silence as you float above a landscape remote and diminutive can never be fully expressed in words. A new dimension has been brought to your life.

Although you will eventually fly solo, the business of getting a glider into the air always requires the assistance of quite a few people, and it's only by their banding

together into clubs that the various tasks can be done. So to find out about gliding, contact a club. If you have any difficulty, the British Gliding Association, Kimberley House, Vaughan Way, Leicester, can help.

Most gliding clubs will accept you as a temporary member, allowing you to have a trial flight or two. Then only when you are sure that you will like the sport do you join and start to learn in earnest. Apart from well-maintained equipment, clubs offer expert instruction, which *is* necessary to learn the sport. Much of the skill and judgement required can only be learnt in the air, but you will make much better use of your time in the air if you really understand the principles involved in each manoeuvre before you fly. We will discuss these principles in the following pages – and hopefully show you the excitement of the sport.

At first, some aspects of the business may seem strange. When your instructor first asks you to feel the controls, the comparative lack of response may surprise you, although larger movements soon create clear effects. The apparent complexity of control movements may seem confusing: will you ever be able to pilot a glider?

Almost everyone can learn to glide. If



## Introduction

you can drive a car, then you can soon learn to glide as well. Indeed, the minimum age for solo gliding is less than for car-driving.

After a few flights, you may not feel you are making much progress. Other club members may be flying solo, and you may still doubt your ability to do so. But your first solo will open new horizons: you will soon learn to soar as well as glide. (Soaring is the name given to gliding using the upcurrents in the air. An aircraft specially designed for soaring is called a sailplane, easily distinguished from its more basic counterpart by its sleeker lines and long slender wings.)

Historically, the pioneers of the sport were for quite some time only aware of one means of soaring, using the wind blowing up a hill. Cross-country flying developed when they used the upcurrents along ridges which faced into the prevailing wind. The skills of soaring then developed, and pilots learnt to make use of rising air in thermals. The world distance record now stands at 1460.8 km (over 900 miles).

The way in which this book is arranged may seem strange to you: handling in the air comes before take-off and landing, and indeed landing before launching. But this is the order in which your instructor will teach you, since you need to know the effects of all the controls – learning about them in mid-air – before using them in the more difficult situations of take-off and landing.

After the instructor lets you go solo, you will be taught how to choose a good field away from base and land in it, and with a basic understanding of navigation, you will begin to learn the art of soaring, and work, if you wish, towards one of the international badges (see Chapter 8).

Even the most experienced pilot has a great sense of achievement as he reaches his next goal: the challenge is always there, and I know pilots in their sixties and seventies still striving for higher qualifications, while others are consumed with a desire to break various records.

Has your imagination been captured? Read on!

## CHAPTER ONE

# A team sport: the first flight

Gliding is a team sport, up to the point at which you become airborne. This illustration shows a typical morning scene at one of Britain's biggest gliding clubs.

If we watch one glider we will see how the team works. One of the group, usually an instructor, will examine the glider to see that it's serviceable; this is called a

daily inspection (D.I. for short). The inspection ensures that all the controls function correctly and that there is no damage to the glider. Completing this task takes a few minutes. When it's done the D.I. book will be signed and the glider is ready to be taken to the launch point, except for one thing – the parachutes.

### 1 *The daily inspection in progress*



## Gliding and Soaring

Basic check list for the Daily Inspection :

### Wings:

- Condition of surface and struts
- Ailerons, and their hinges and control runs
- Airbrakes and their mechanism

### Tail:

- Condition of surface and struts
- Elevator and rudder: hinges, control runs, trim-tab linkage, cable tension

### Fuselage:

- General condition, including skid, wheel and tailskid
- Rudder pedal springs
- No loose articles
- Canopy clean and working smoothly
- Harness complete
- Instruments and batteries working
- Release-hook operation

### Controls:

- Check for full and free movements, and that the controls operate in the correct sense ; (e.g. that moving the control column to the left *does* make the *left* aileron go up)

### Equipment:

- Parachutes
- Barograph
- Cushions

This list is intended only to give an idea of the items involved in a D.I., and should never be taken as complete for an actual D.I. ; for fuller details, see the D.I. book, for example that produced by the B.G.A.

Should the thought of using a parachute concern you, don't worry. Gliding is a safety-conscious sport. After all, you wear a life jacket in a dinghy even if you can swim. The odds against having to use a parachute are about one in four million. With the 'chutes stowed carefully in the cockpit we are ready to go. With one person holding the wing-tip, always on the side from which the wind is blowing, the rest disperse themselves around the glider ; one or two on the tail and the rest pushing on the nose or the front edge of the wing. The glider is usually moved backwards.

When there are not enough people to manhandle the glider it can be pulled with a car and a rope. You still need four people though ; in the car, on the wing-tip, by the tail and at the nose. The man at the nose is particularly important to stop the glider running into the back of the car should it stop suddenly.

As you approach the launch area things start to look a little more organised than they did at the hangar.



*2 In this view of a car-launch, it may appear that the glider is not following the car. Because the wind is across the runway from the left of the picture, the glider is being flown into the wind so that the glider flies down the runway, then when the cable is released it will fall on the runway.*

## A team sport

Now it is safe to cross the landing area and join the queue of gliders waiting for a launch. At the launch point the gliders are being towed into the air by a truck and a length of wire; as well as the gliders waiting their turn there are others being taken from large boxes on wheels and put together. The reason for these trailers is to retrieve the glider if it lands away from the airfield, and as hangar space is at a premium it may as well be kept there.

The glider in which you are going to fly is getting near to the front of the line. For simplicity's sake, and also because you will not go high enough to use it on your early training flights, the parachute will be



dispensed with and a cushion put in its place. You will be shown how to get into the cockpit and having climbed in you settle down in your seat. The instructor shows you how to fasten the straps and hold the controls.

The instructor now adopts a slightly more formal manner as he starts to get ready for flight. He checks the various controls and asks your weight; there are limits to the loads a glider may carry. Straps tight, instruments checked, trim set, canopy closed, brakes closed and locked. (For an explanation of 'trim' and 'brakes', see the glossary, p. 62.) The next step is to attach the cable with which the glider will be launched. The device to which it will be attached, the release hook, is also checked to ensure that the cable can be released, and, failing that, that it will release automatically – an additional safeguard.

The glider is now ready to be launched and anyone in front of the machine moves to one side. The instructor gives a series of orders: 'Is it all clear above and behind?' We don't take off if there are other gliders landing. 'Yes,' says the signaller who, on the command 'Take up slack,' waves the signalling bat to and fro in a semi-circle below shoulder level. The towcar now moves gently forward until the cable is tight. Now the command 'All out' is given. The signaller waves his bat to and fro above his head but still watches the glider

*3 Left: A student in the cockpit. The straps around the waist (not visible in picture) should be tightened first, then the shoulder straps. Notice how the stick is held: only a light grip is required (control forces are small), and the right hand is always used, the left being required for other controls*

## Gliding and Soaring

in case anything untoward occurs and a stop signal has to be given. Should *anyone* shout 'stop' the signaller will hold the bat overhead to indicate to the car driver that the launch should be discontinued. The glider rolls forward as the car accelerates and with a gentle surge is soon airborne. Within seconds the glider is climbing steadily and you look over the side at the receding ground.

Soon the nose of the glider goes down and there is a 'clunk' as the cable is released. Suddenly it's quieter, the glider is being flown more slowly than during the launch. For a few minutes (it will seem much less), the instructor will turn the glider around and point out the local

landmarks. Eventually things on the ground start to look bigger, the nose goes down a little and your instructor says 'We are going in to land.' Before you realise it the noise of the glider's wheel trundling across the grass breaks the spell. As the glider comes to rest the wing dips gently to the ground. The helpers arrive and you climb from the cockpit and assist the others to push the glider back to the launch point. 'What was it like?' your friends ask. You struggle to describe the thrill, the beauty, the sensations, but part of that experience will remain unspoken; try as you might you will never be able to describe it.

Back at the launch point your instructor

*4 Attaching the cable. After its release, the cable's fall is slowed by the parachute, shown here lying on the ground*





*5 Aerial view from 500 feet, in the climb during launch*

will have a few minutes to talk to you about the flight and answer any questions. Now is the time to discuss how the controls worked : you can see how the forward and back movements of the stick operate the elevator, the control surface at the rear of the glider, hinged from the horizontal tailplane (or in U.S. terminology, stabilizer). Moving the stick back moves the elevator up, and the glider climbs ; stick forward moves the elevator down, and the aircraft descends.

Sideways movements of the stick work control surfaces on the wings, called ailerons. That on one wing moves in the opposite direction to that on the other : with the stick to the left, the left aileron is up and the right one down ;

stick to the right reverses the effect. This is the control used to bank the glider.

The remaining control is the rudder, the vertical control surface hinged from the fin. This is operated by pedals.

The detailed effect of controls is discussed in the next chapter ; a lesson in the effects of controls will probably be part of your second flight. If you fail to understand any of your instructor's explanations, do not hesitate to ask questions. There is never any need to be embarrassed because you do not understand. It is essential that you have no misconceptions about the first principles before you continue your training. If some of the terms in the paragraph above are new to you, look at the glossary.





6 The cockpit of a Pilatus glider: the instrument panel is shown in the diagram below.

The variometer shows the rate of climb or descent.

The altimeter shows height, the large needle showing the hundreds of feet, the shorter with the ring, thousands, and the shortest, tens of thousands. In the diagram, the altimeter reads about 1920 feet. The small figures showing through the window are atmospheric pressure settings (in millibars): since the altimeter works by measuring air pressure, it must be adjusted to take account of the day-to-day variations in pressure, and the correct pressure needs to be set opposite the mark.

The needle of the turn and slip indicator shows the direction and rate of turn: the 'OFF' flag disappears when the instrument is working correctly. It is essential that the pilot knows when the instrument cannot be relied upon; the turn and slip indicator is fundamental to instrument flying.

The ball of the turn and slip indicator shows when the glider is in balanced flight: it is discussed on page 22.

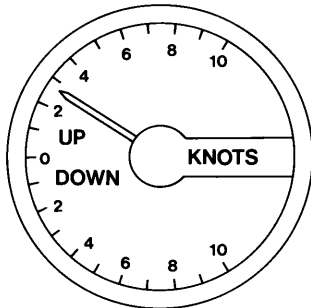

variometer

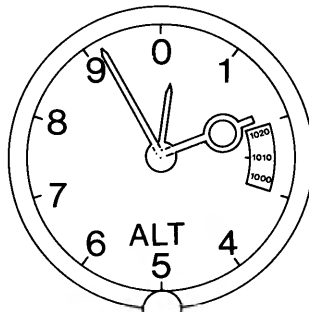

altimeter

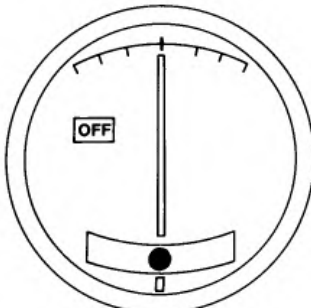

turn and slip indicator

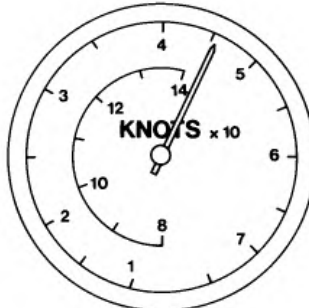

airspeed indicator

## CHAPTER TWO

# Basic skills and co-ordination

As mentioned in the introduction this chapter will not start where you expected. It's not going to tell you how to get the glider into the air or back down on the ground again but simply how to fly it while it's airborne and well away from the ground, a bit like learning to drive a car in

a wide open space with no worries about where you are going or other traffic. In the glider, although there may be other traffic to start with, your instructor will concern himself with that, and not worry you with it, but he will point it out to you.

Let's suppose the glider is airborne,

*7a, b The rudder is the rear of part of this vertical surface: the forward part is the fin, and is fixed. In the right hand picture, the rudder is shown deflected to the left, and the horizontal surface, the elevator, can be seen in the down position. The additional flap on the right of the elevator is the trim tab, which can be adjusted to eliminate the forces transmitted to the control column when the glider is in flight*





## Gliding and Soaring

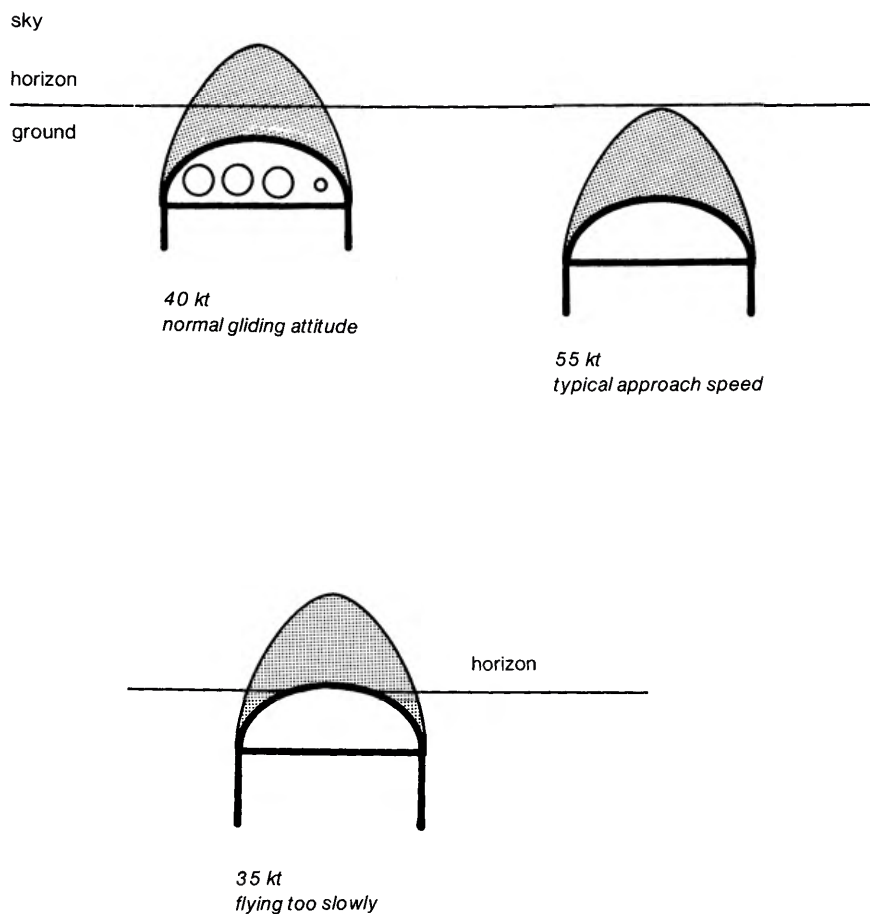

8 The word 'attitude' is used to describe the relationship between the nose of the glider and the horizon. The speed at which the glider flies is related to attitude; when attitude is used to control speed, allowance must be made for the time the aircraft takes to accelerate and the lag in the response of the air speed indicator (ASI)

having been pulled aloft by an aeroplane, an aerotow, to a height of 3000 ft. More often than not the launch height by aerotow will be to 2000 ft, but to give you more time in the air to develop the basic skills your instructor has decided on the extra height.

You will be asked to place your hand on

the stick and your feet on the rudder pedals in the same way that you were shown before the flight. The glider will be flying steadily along at a speed of 40–45 knots (a knot is the common measure of speed in flying and 1 kt is a nautical mile per hour; a nautical mile is 1.15 statute miles so 40 kt is 46 miles per hour). An

## Basic skills and co-ordination

important point to understand is that the glider has this speed through the air because it is descending, sliding down a hill as it were, getting the forward motion from gravity in the same way as a skier or a man on a bob-sleigh.

Flying along at this speed will present you with a certain picture comprising the nose of the glider, the horizon and the terrain between them. The first skill you must acquire is to control the speed of the glider. This is done by controlling the attitude—back to the skier again: to ski at a high speed you must go down a steep hill, so must the glider slide down a steep aerial slope to fly fast.

The shallower the slope the slower the glider will fly. How do we control this? By the stick's forward or backward movement operating the horizontal control surface on the tailplane, which you will

recall is the elevator. Only small movements of the control are required and the 'attitude' at different speeds will appear as in figure 8.

So with the elevator we control the speed. There is one quite vital point in this attitude/speed relationship: if we change the attitude, lowering or raising the nose, then it takes a moment or two for the speed to alter and settle to its new value. The significance? Simply that attitude is a more reliable guide than the air speed indicator when you are trying to select a particular speed. While you are learning to glide remember this and *look out*. Later in your training you will learn that for certain phases of flight there are particular speeds at which you will fly the glider.

Having learned to use the elevator you will now learn the use of two other controls, the ailerons and rudder. Now you

*9 The ailerons are the control surfaces at the end of each wing. Here the left one is deflected downwards, and the right one up. The stick is to the right, and the aircraft will bank (roll) to the right. The trim tab shows clearly as part of the right-hand side of the elevator*



## Gliding and Soaring

may have preconceived ideas about the rudder, which probably stem from learning about boats before aeroplanes or gliders. Having said that much, let's ignore the controls for the moment and consider how a glider turns. The one thing it doesn't do is keep its wings level; it is turned by banking and figure 10 will make clear what is meant.

First of all you must understand what the ailerons and rudder do. Look again at the illustration to visualise their effects.

Although you can't see the control positions in this illustration the stick is over to the left. Can you imagine airflow over the wings? It will tend to push the left wing down because the aileron is up and the right wing up because the aileron is down. Once you accept this it's simpler to think of stick movements and wing movement, stick to the left, left wing goes down, and stick to the right, right wing goes down.

There is one important point here which you should be able to work out for yourself, and that is to create the view over the nose, corresponding to that for different attitudes shown in figure 8. It will not be necessary to keep the stick over to one side (and hence the ailerons deflected). Once the correct angle of bank has been achieved then the ailerons must be used to stop the bank increasing and again for any small corrections to keep it constant.

Where does the rudder come into it? It is used in conjunction with the ailerons, for reasons which require a little thought. If the bank is made using the ailerons alone (a manoeuvre which you may try out on your second or third flight), then an adverse effect becomes apparent. The glider will hesitate before starting to turn,

or may even swing in the opposite direction, unless rudder is used to keep the glider headed directly into the airflow. This undesired swing, more properly called 'yaw', is known as the secondary effect of aileron.

You will remember that when you move the stick to bank, one aileron goes up and the other down. The down-going one gives more resistance to the air than the up-going, and the resulting difference in the drag on each wing causes the aircraft to swing. (Drag is the resistance to motion through the air.)

In a turn, therefore, the rudder is used to control yaw: how much control is required is a refinement you'll learn later. The operation of rudder and aileron together requires co-ordination, which is an essential skill to learn.

*10 In (a), the glider is in level flight: the airflow is the same over both wings. In (b), the ailerons deflect air in opposite directions on each wing: the glider tips to the side of the upwards aileron. This produces a force which pushes the nose round, achieving the turn we want. In (c), the ailerons have been returned to the neutral position, and the aircraft holds its banked position*

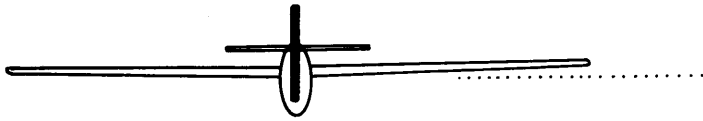

attitude picture

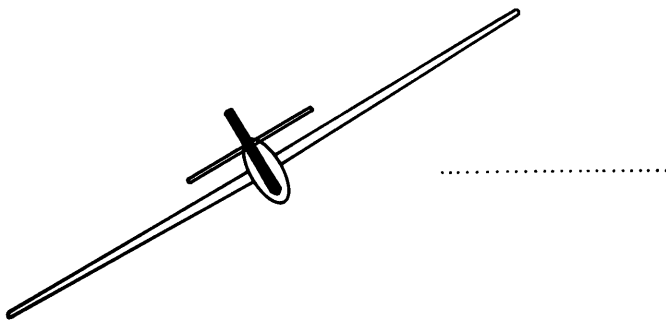
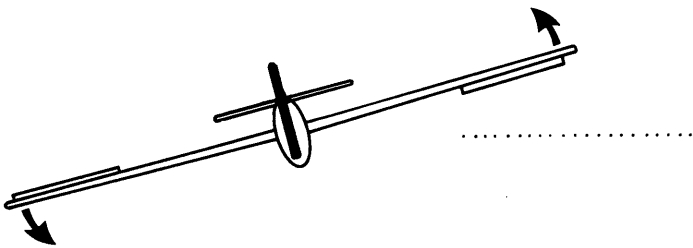

## Gliding and Soaring

aircraft moving  
forward and to left

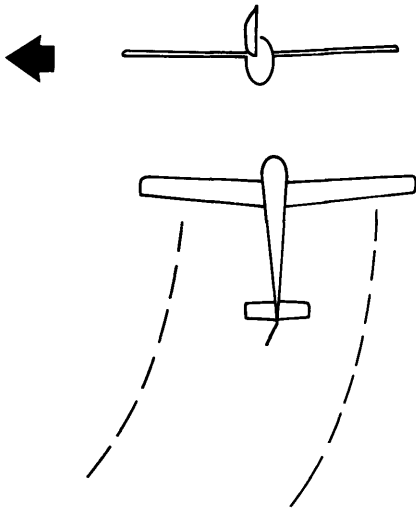

(a) (i)

view from  
rear

(ii)

plan view

The diagrams may help you to understand the movements used to keep a glider turning (figure 11). They represent two extreme situations: the first is impossible in practice, the second rarely occurs. Consider first, trying to turn with the wings level using rudder alone. You may think this is quite possible, but as soon as the aircraft starts to turn, the airflow over the two wings stops being identical, and the resulting difference in lift causes the aircraft to roll.

Secondly, think about a turn with the wings vertical: this is possible using elevator alone. Since the aircraft is tipped over, 'up', the effect of the elevator, now becomes 'left' in the illustration. (The pilot will still talk of the aircraft pitching nose up however: effects of controls are always referred to the aircraft.) The trouble here is that when the wings are vertical, they are producing no lift upwards to balance the glider's weight, and the glider will lose height. In practice, we can counteract this with rudder: you may like to think which way we need to apply the rudder.

(b) (i)

aircraft moving  
forward and to left

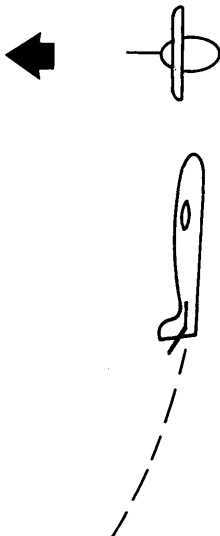

view from  
rear

(ii)

plan view

So an actual turn is done with the glider in an attitude somewhere between

11 A turn is made at an angle of bank somewhere between the two extremes shown here. The top diagram shows a turn with the wings level, which you might think could be achieved by using the rudder alone. In practice, as explained in the text, this is impossible. The lower drawing shows a turn with the wings vertical, using the elevator

## Basic skills and co-ordination

wings-level and vertically banked, and so you need *some* rudder and *some* elevator. The ailerons are used to put the glider in the banked position : it is important to understand that once the aircraft has banked as far as you want, you need to return the ailerons to the position, normally near neutral, required to keep that amount of bank. The amount you move the stick to one side controls the rate of roll, and not the amount of bank.

The control movements appropriate to the turn entry and the established turn have now been considered. Before putting them all together as a complete turn there is one vital point that has been neglected and that is lookout.

Looking out from a glider, not just admiring the scenery, is quite a difficult business ; there are so many places that one can look. If the glider were transparent you could look everywhere. As it's not, then accepting the limits to the field of view, the blind spots, should make you even more careful. Another aircraft or glider to constitute a hazard must be at a similar height to you. Now it's often quite easy to see them silhouetted against the sky or the ground, but when they're on the horizon it's much more difficult. So while not neglecting the airspace above and below, your lookout should concentrate on the horizon and especially in the direction of the turn.

### *In summary :*

To enter (to the left) : stick and rudder to the left : a similar amount of movement is required on each control. Once the glider is banked the required amount, stop the bank increasing with the ailerons and reduce the amount of rudder.

Simultaneously with the first control movement, gradually ease the stick back ; the movement is not all that much and you can think of it as a backward pressure on the stick. The glider is now established in the turn ; continue to keep a good lookout, especially in the direction of the turn.

Established in the turn make any corrections required as follows :

### *Speed (via attitude) with the elevator :*

Lower the nose, stick forward (or relax the backward pressure) if the speed is low and the reverse if the speed is high. There is one slight complication here : if the speed is high and easing back on the stick doesn't reduce it then it almost certainly means that the bank has been allowed to increase too much. In this case reduce the bank before trying to reduce the speed.

*Angle of the bank :* Remember that each movement of the ailerons requires co-ordinated use of rudder. To reduce bank (in the left turn) it's right stick (aileron) and rudder ; to increase it, left stick and left rudder. Once the correction is made the ailerons will be altered to keep the bank constant and the rudder restored to its original setting, a small amount of left rudder.

Before leaving the turn it is necessary to examine the use of rudder in a little more detail. The rudder is best considered as a balancing control. Balanced flight can best be termed as flight without any sideways movement, known as slip if into the direction of turn, or skid if out of the turn direction or while travelling in a straight line. There are ways of telling when the glider is not in balanced flight and these are shown in figure 12 overleaf.

## Gliding and Soaring

The instrument with the ball is, in effect, a spirit level; the string a sort of weather-cock. The ball is the easiest to interpret. If you want it in the middle, which is where it should be for a correctly balanced turn, imagine kicking it there. If it's out to the right move the right foot forward and if to the left move the left foot forward. The principle is the same with the piece of string but the sense is opposite.

There is one other way of telling whether the glider is balanced or not, traditionally known as 'the seat of the

pants'. With experience you become aware of a tendency to slide in or out during the turn.

It wouldn't do to end with the glider still turning. I haven't talked about coming out of the turn simply because it should be fairly obvious; aileron and rudder are applied in the opposite sense to that for entry with a simultaneous relaxation of the backward pressure on the stick.

This, then, covers the rudiments of turning. When you first try it you may find the sensations disconcerting and as the

*12 The means of telling if a turn is balanced: the piece of string or wool is attached at its lower end to the canopy, and lies along the canopy (the position shown as the dotted line) whilst the glider meets the relative airflow head-on. When it doesn't, the string is blown to one side. In a similar way, if the turn is unbalanced, then the ball is displaced to one side or the other by forces resulting from any sideways movement. If the turn is balanced, the ball is in the centre*

left turn

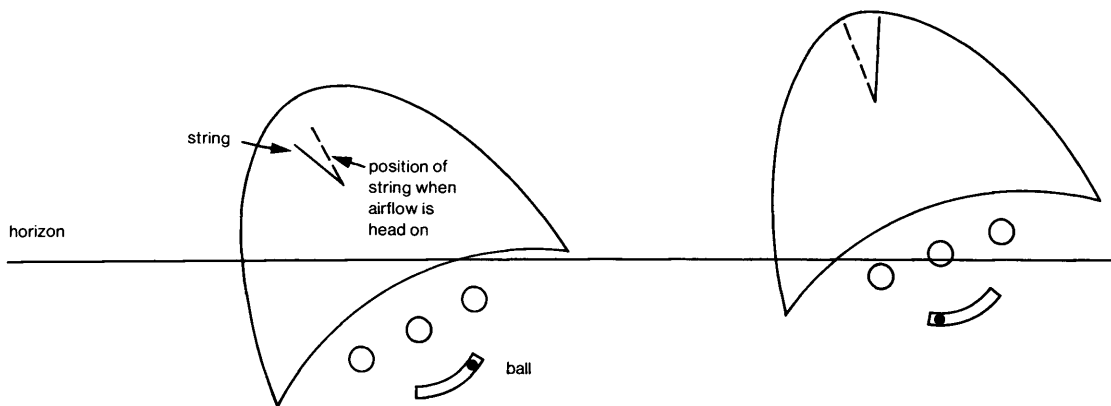

*Skidding out; too much rudder  
Less left rudder required  
to align aircraft with airflow*

*Slipping in; insufficient rudder  
More left rudder required*

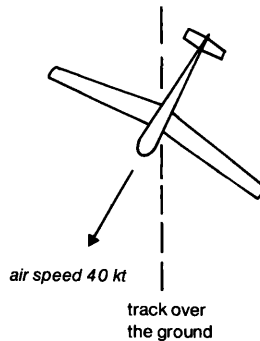
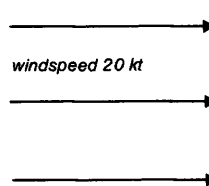
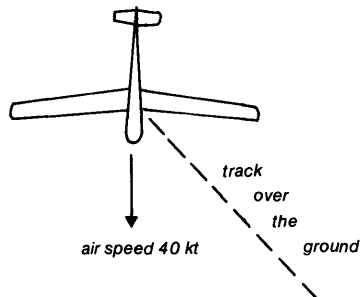
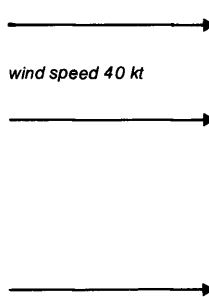
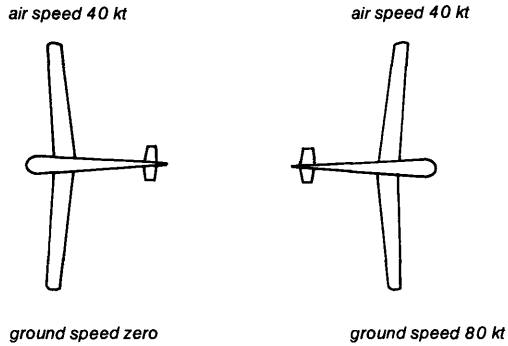
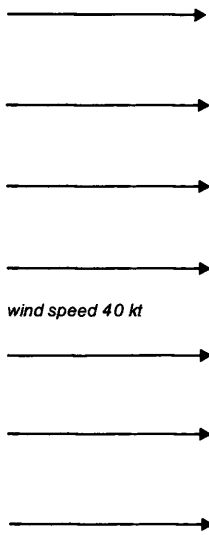

13 The effect of wind on the glider's speed and direction over the ground. Flying into wind, or down wind affects only the speed of the glider (upper diagram). Flying cross-wind causes the glider to drift, so its track over the ground is not the direction in which the nose is pointing (middle). To make good a particular track over the ground requires that an allowance is made called drift correction



## **Gliding and Soaring**

glider banks you may try to stay upright, but don't; lean with the glider as it banks. Once you have developed the ability to turn and fly the glider you will need to extend that skill by learning to straighten from a turn in a direction of your choice. All this requires is a degree of anticipation, making an allowance for the time it takes to level the wings.

In learning to fly the glider accurately in a particular direction you will discover that a glider isn't always going the way

it's pointing. This is due to the wind, and some simple examples, as in figure 13, illustrate the fact, which assumes greater significance when you come to land.

The turning practice and co-ordination are the basis of all flying skills; the better you are at it the better a soaring pilot you will become. Before you can become a soaring pilot, however, there are several other skills to be mastered as well as gaining the necessary perception and judgement.

## CHAPTER THREE

# Judgement and decision making for landing

Once you have acquired the basic flying skills you will begin the second phase of your training. In it you will develop your perception and judgement and learn about certain vital decisions which have to be made on every flight. Most of this is to do with coming in to land.

When you can no longer soar you have started the sequence prior to landing. Indeed many of the training flights will have no other purpose for becoming airborne than to practise a 'circuit' and landing. What is a circuit? In flying or gliding parlance it is a pattern, usually rectangular in shape, flown round an airfield for the purpose of landing. It is shown in figure 14 overleaf.

Once the glider has descended to 800 ft or so it should be in the starting area – so height above 800 ft is used in such a way as to arrive in that position. A typical training launch will have taken the glider to 1200 ft or so. Once in the starting area, the position of which varies on a number of counts (see later), the commitment to land is made. The appropriate height will have been read from the altimeter but you should try to avoid using it thereafter and concentrate on the view of the airfield. Not using the altimeter is important because on later flights, or any flight in

which the landing place is not the same as the take-off, the reading will not be correct.

The basic pattern is begun but maintained only so long as the glider has adequate height, which you will eventually learn to judge from the view of the landing area. If it is lower than it should be then it must be turned in the direction of the landing area and flown towards it until the perspective is right again. Appreciate that the glider is influenced to a great extent by rising or descending air. The latter can quickly reduce the available height. Depending on where the pilot finds himself short of height, so the circuit will be adjusted. (Figure 15)

There are many other variations, including landing across the airfield, but always adjustments are being made and this is the judgement and decision making you must learn.

One critical decision is where to position the base leg. This depends (for any one type of glider) on the strength of the wind and any terrain effects – hills and slopes which create turbulence and sinking air. The position of the base leg doesn't have to be exactly right because the pilot has a special control called air-brakes (or spoilers in older gliders) with

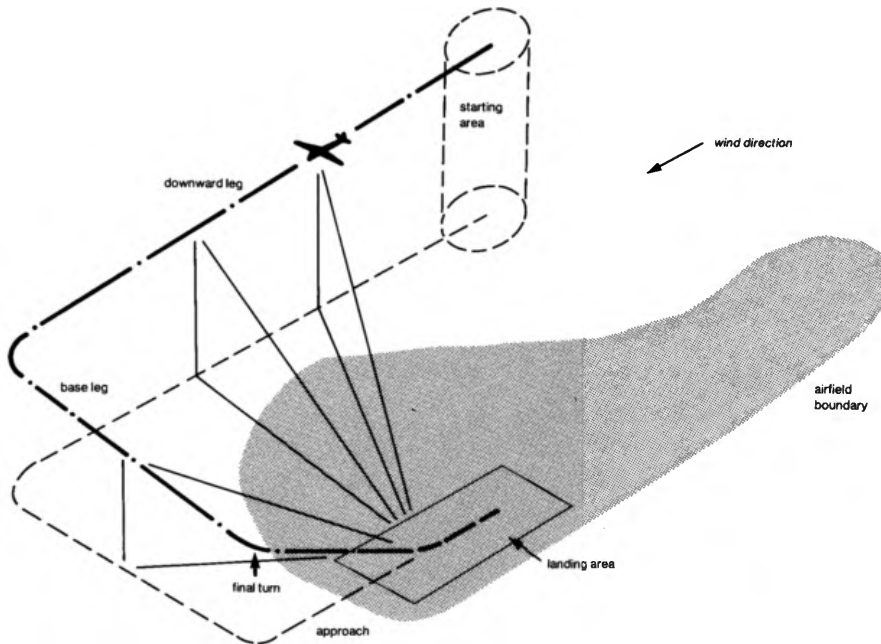

14 A circuit. The starting area is near the upwind end of the airfield, and off to one side. The downwind leg is parallel but opposite to the landing direction. The base (or 'crosswind') leg is at right-angles to the landing direction, and it is for this phase that drift correction is necessary (see fig. 13), to prevent the wind drifting the aircraft away from the airfield

15 Correction for height before landing. If you arrive at the starting area with less height than intended, then the circuit flown must be adjusted accordingly: the downwind leg must be moved closer to the airfield. If the situation still does not improve, then the circuit will have to be cut short (as at A). From B, it is possible to make the pattern flown coincide with the circuit pattern, from the middle of the base leg

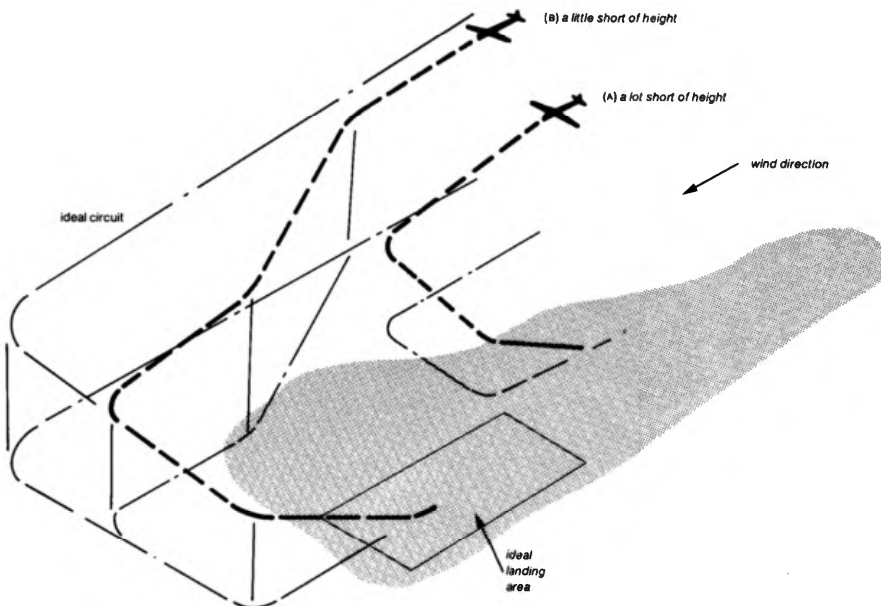

## Judgement for landing

which to adjust the approach. The range of control is from the shallowest angle, using no brake at all, to the steepest, using all the brake. Don't be misled by the word airbrake; the control is for steepening the glide angle, not for reducing the airspeed. (Figure 16)

The approach angles are also altered by the wind and the pilot's aim is to arrive in the middle of the approach 'funnel' whatever the conditions. In no-wind conditions the base leg is at its farthest-back position from the landing area and is positioned proportionately closer the stronger the wind becomes. The other factor which effectively determines the position of the base leg is the height at which the final turn is completed – 250 ft or so, rarely less but sometimes more.

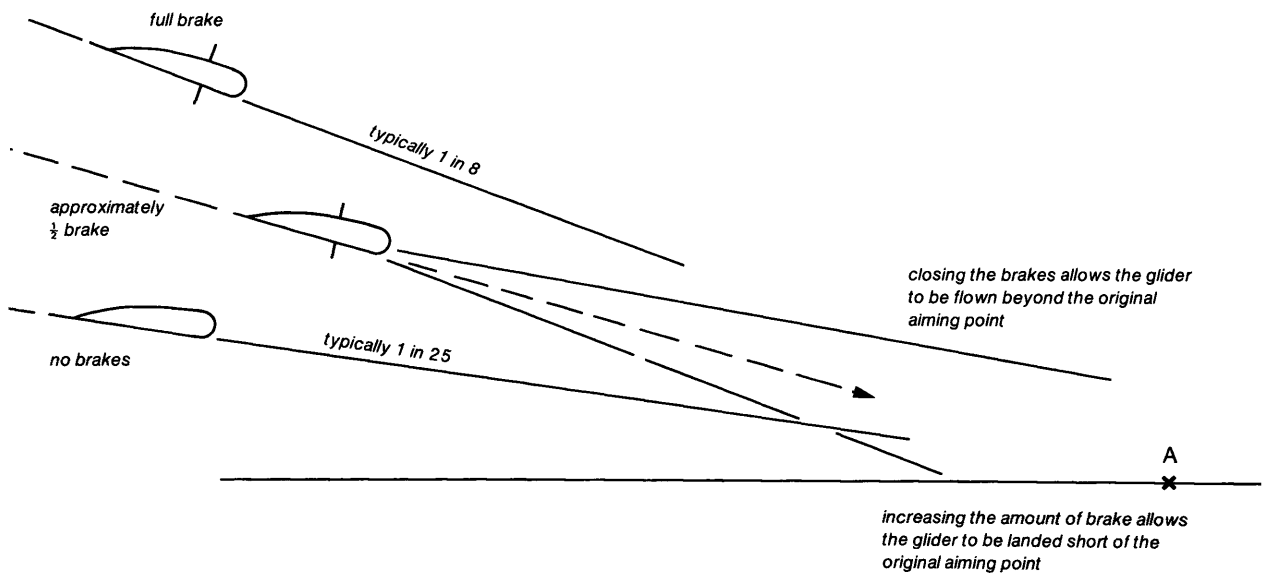

*16 The use of airbrake to adjust the glide angle. The pilot aims to be in the middle of the range of possible glide angles, making an approach using half brake. This allows for a margin of error in either direction. It is good practice to choose a touch down point (A), and try and land there, but bear in mind that you may have to change your choice if the original point becomes obstructed by another glider. Never land closer than two wing-spans from another glider*

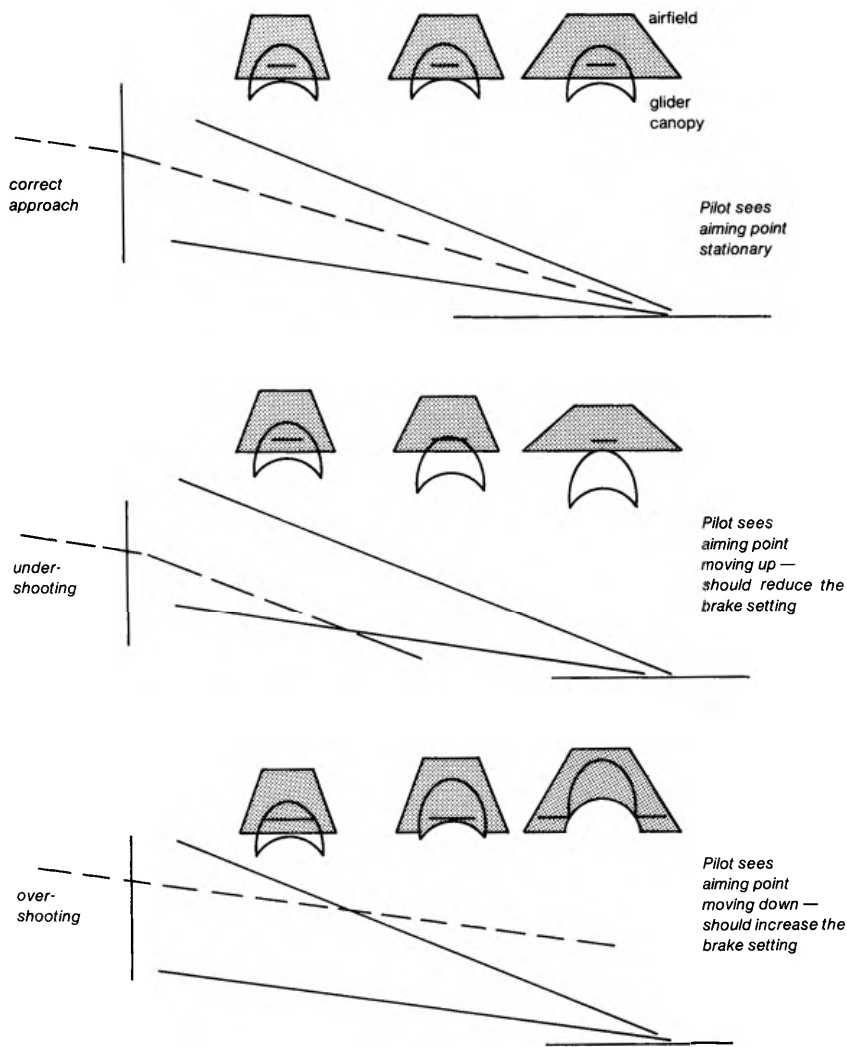

*17 Judging the approach. This is one of the more difficult parts of your training. These diagrams show that the perspective of the landing area is not the only useful aid, and the relationship of the aiming point to the glider also helps. In the overshoot case, the aiming point is moving down 'towards' you, and in the undershoot, up and away.*

To make adjustments to the approach the pilot alters the airbrake setting, but the perspective of the approach, the angle at which the landing area is seen, varies with the wind strength; you will, however, be taught to recognise deviations from the correct path, which are more easily illustrated than described. (Figure 17) Once a correct approach is established

the pilot should maintain a constant setting of the airbrakes, especially for early attempts at this exercise. Further adjustments are unnecessary if you are certain that the glider is going to reach the landing area which, incidentally, is well in to the airfield to allow a safety margin. There is one important proviso with regard to keeping a constant brake

## Judgement for landing

setting ; if the glider is losing speed the airbrake setting should be reduced, even closing them if the speed loss is great. The cause of a loss of speed is an effect near the ground called 'wind gradient', slowing down of the wind due to the friction of the earth's surface. This may cause the glider to lose a little speed. So it is essential to monitor the airspeed, glancing at the instrument every few seconds or so. If the speed is maintained down to a height of about 50 ft then further losses should not be critical.

Look well ahead for the landing. The landing sequence starts with changing the relatively steep approach path to a horizontal one, that is parallel to the ground. This change of direction is called rounding out. The horizontal flight path is called the 'hold off'. The aim in this phase is to keep the glider in the air for as long as possible to get the lowest possible speed for landing. Remember that a glider can't fly horizontally for long — like the skier, except that the skier stops and the glider stalls. Stalling occurs when the air flows over the wing so slowly that it ceases to flow smoothly, and so there is not enough lift to keep the aircraft flying. From a height of a few inches above the ground, a stall doesn't matter at all — indeed it ensures the lowest possible landing speed, which is desirable, especially if the ground is not smooth.

Having got the glider on the ground the natural reaction is to relax. Don't. The landing is not complete until the glider comes to rest. As it slows down you will find that you need progressively larger movements of the controls, ailerons to keep the wings level and the rudder to keep straight. If the landing was a good one, that is the touchdown was at the

lowest possible speed, then the stick will already be to the back limit of its travel ; wherever it is at touchdown you should continue to move the stick back until it is at its aft limit. Once the glider has come to a halt it is good practice to stay in the cockpit and strapped in until help arrives.

*18 The final approach. The glider comes to about 50 feet, just before the start of the runway as another waits its turn for launching. The airbrakes can be seen as projections on the wings.*



## CHAPTER FOUR

# Slow flight

On the same flights that you practise flying the circuit, making an approach and landing the glider, you will be extending your knowledge and skill in other respects. One very important part of every pilot's training is learning about the potential hazards of flying too slowly. Have you ever tried to ride a bicycle very slowly or balance it when stopped? It's possible but difficult, and the risk of falling off is great. The analogy doesn't quite hold true, though, because there is a minimum speed at which the glider can be flown, which is called the 'stalling speed'. The glider needs forward movement, you will remember, for its wing to generate the force, called lift, to support its weight. Below a certain speed, the stalling speed, the wing no longer generates enough lift to do this. Not all the lift is lost so the effect isn't as abrupt as falling off a bicycle.

What you must learn is how to recognise this critical situation. Two of the 'symptoms' of the approaching stall are therefore the attitude and the airspeed. Others are the quietness in the cockpit and the fact that the controls are less effective at the lower speeds. Finally, just before the stall you may feel a gentle shaking of the tail surfaces; this is due to

the increased disturbance of the airflow by the wing, which is no longer working at an efficient angle. The effect is called buffeting and is a very useful indication that you are flying the glider too slowly. The symptoms, then, are the key to the approaching stall – nose higher than usual, reducing airspeed, quiet in the cockpit, the controls less effective (due to the reducing airspeed), buffeting and finally a nose drop (in spite of attempts to hold it up).

This last response, your attempt to hold the nose up, will be instinctive until you have learned to recover from the stall.

Recovery is straightforward: ease the stick forward, regain flying speed, and then return the glider to its normal gliding attitude.

Some height will be lost in this manoeuvre and, for practice purposes, it will be carried out at a height which will make due allowance for this. The practice should convince you that flying too slowly near the ground is a risk not worth taking and in circuit flying (see Chapter 3) you will note that speeds well in excess of the stalling speed are maintained throughout the circuit as an additional safeguard.

The characteristics of the stall will vary from one glider to another and even in the

same glider may be different, depending on the circumstances. The dropping of the nose will not always take place; if it doesn't then the glider will still lose height quite rapidly. These variations of the stall can occur in straight or turning flight and are not necessarily pilot-induced, in that a gust of turbulence can be the cause.

Common sense dictates that when practising such manoeuvres you take certain precautions, just to be on the safe side. Check that your straps are tight, that there is nothing lying loose around the cockpit and that it's all clear below by turning and looking there. Turns in both directions are the usual practice. If you are wondering about these precautions, especially the tight straps and the check for loose articles, then be assured that there is no violent motion and little physical sensation except perhaps a feeling rather similar to stopping in a high speed lift (elevator) or going over a hump-backed bridge.

The stall can, however, develop into another manoeuvre called a spin, in which the glider descends in a nose-down attitude, rotating more or less about its own axis and losing height quickly. For this manoeuvre the safety precautions are

more significant. Although the sensations in the spin are much more marked they are no worse than one can experience on many fairground or amusement-park machines. Gliders recover quickly and easily from spins with a simple drill:

- 1 Full opposite rudder (spinning right – full left rudder).
- 2 Ease the stick forward *until the spinning stops*; in most gliders only a small amount is necessary but they do vary. In easing the stick forward keep it central.
- 3 When the spinning has stopped centralise the rudder and:
- 4 Pull out of the dive.

This drill must be engraved on your mind and instinctive. It's worth noting that if the speed is high in the recovery less height will be lost by opening the air-brakes, which will stop the build-up of speed. The spin or the stall can occur whether the glider is flying straight or turning and in the turn it should be noted that the stalling speed is higher than in straight flight. For most of the turns you will do in the course of your training, with up to forty-five degrees of bank, the increase will be around three to four knots.



## CHAPTER FIVE

# The launch

There are four different ways of getting the glider airborne: catapult, more usually called bungee, winch, cartow and aerotow. Each has its merits and the choice is governed by the type and location of the airfield and economic factors.

### ***The bungee launch***

This simple form of launch needs only an elastic rope, six to eight people, depending on the weight of the glider, and a hilltop facing a wind which must be of moderate strength. The contour of the hillside must be suitable for the crew to run down. The rope is laid out in a 'vee' in front of the glider and attached by special fittings which avoid the need for the pilot to operate the release. The tail of the glider will be held up by one of the launching team so that the weight of the machine is on its skid, which stops it rolling forward while the rope is stretched. The remainder of the crew take hold of the ends of the vee rope. On the command 'walk' they start to stretch the rope. When it is part stretched the command 'run' is given. Ultimately the man at the tail can no longer hold it and the glider rolls forward. Helped by the slope of the hill it gathers momentum and lifts off the hillside to fly

in the air deflected up by the hill – the hill lift.

### ***Winch and cartow***

These two methods are similar in that they use a length of wire or cable. The glider is pulled through the air in much the same way as a kite, except, of course, that the pilot still controls the glider. The difference in the methods is that the winch is a stationary device which reels in the wire while the autotow, another name for cartow, uses a fixed length. For the cartow an airfield with runways is essential; the winch can be used from a grass field.

The power from the winch or car starts the glider from rest and accelerates it to take-off speed (the ground run). More speed is required before the glider can climb steeply, but after take-off and as it accelerates more it can climb gently (the initial climb). Above a hundred feet or so, as long as the speed is adequate, the glider's nose can be raised progressively into what is called the fully-developed-climb phase. Towards the top of the launch the nose is progressively lowered to place the glider in a level attitude as the car comes near to the end of the runway or the glider is nearly overhead the winch.

The nose is lowered slightly before the pilot releases the cable. The release is a yellow-coloured knob, usually on the left-hand side of the cockpit, and is pulled twice to be sure the cable is released.

The height of the launch is governed by a number of factors such as the wind strength, airfield and cable length and the power available from the engine.

A fair degree of skill is needed to drive the car or the winch – another aspect of the team sport. Communication between the pilot and the driver, after the launch signals of ‘take up slack’ and ‘all out’ have been given, is one way and consists of the pilot yawing the glider’s nose from side to side (having lowered it slightly first) if the launch is too fast. For too slow a launch the usual practice is to abandon the launch by releasing the cable.

### **Aerotow**

An aeroplane fitted with a special hook, the same or similar to the one on the glider, provides a convenient means of launching. It has the advantage that the glider can be taken to the lift or because of the greater launch height there is more time available to find it.

A rope, between 100 and 120 ft long, is used to attach the glider to the aeroplane. All the glider pilot has to do is follow the aeroplane; it’s a type of formation flying. Should the glider pilot be unable to stay in position he can always release the rope, as can the aeroplane pilot if he is at all unhappy with the progress of the tow. The aeroplane pilot, by the way, is usually called a tug pilot.

A standard system of signals exists for

the pilots to communicate with each other. If the tug pilot rocks his wings then the glider pilot must release immediately. If he is unable to do so then the glider is flown out to the left-hand side and the pilot in turn rocks his wings. In this event, a very rare situation indeed, the tug pilot would release the rope; the glider pilot would land, making due allowance for rope trailing below by flying slightly faster than usual and avoiding any obstruction which the rope might catch. (Figure 19)

### ***Launch failures and further aspects of circuit and approach planning***

When a launch is not completed satisfactorily or does not achieve the anticipated height, the pilot will be faced with problems of planning different from those already considered.



19 An aerotow launch, showing the length of the cable

## Gliding and Soaring

The launch may not provide the height expected for various reasons, such as bad driving or a sudden alteration of the wind, but by far the most common is the cable-break. Bearing in mind that the glider may be climbing at an angle of up to forty-five degrees it should be obvious that it must be put into a safe attitude and a safe speed maintained. The immediate action then is to lower the nose, release any cable still attached and check the airspeed, which if it's lower than 50 kt should be increased to that figure. The pilot is now faced with

a decision or series of decisions. If there is enough space to land ahead then this is the safest alternative ; if not, then the immediate need is to make a turn to one side, the downwind side if there is any crosswind. The advantages of turning to the downwind side will be best appreciated by studying figure 21 .

One of the pitfalls in these situations is in relating each of the alternatives to the height at which the cable-break occurs. Although the height is significant, other factors are equally important. These are

*20 One should ensure that at any stage of the launch it is possible to recover quickly from the climbing attitude to a safe flying attitude, should the cable break. Up to 100 feet or so, this requires that the glider is in an attitude only slightly nose-up. Here the glider is being climbed too steeply*



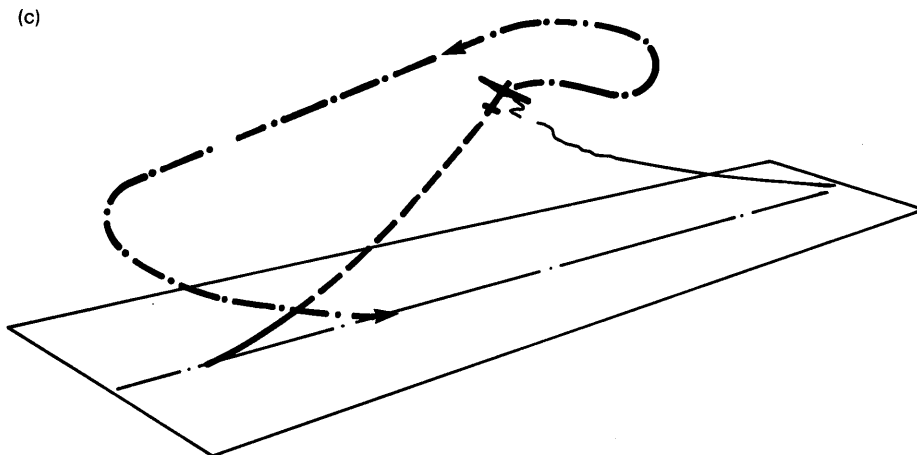
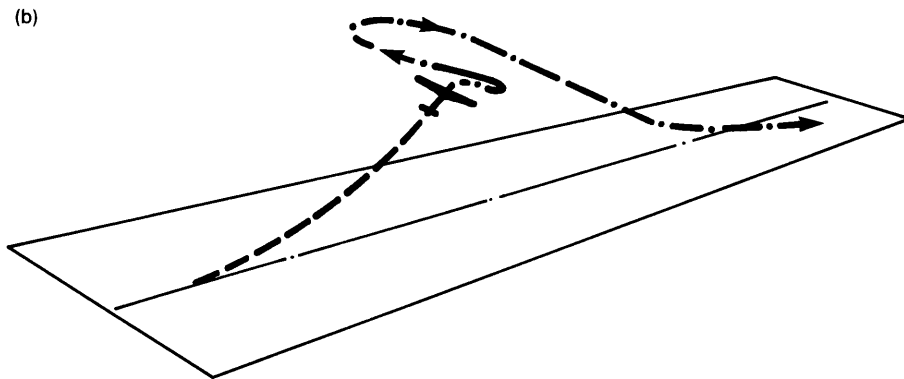
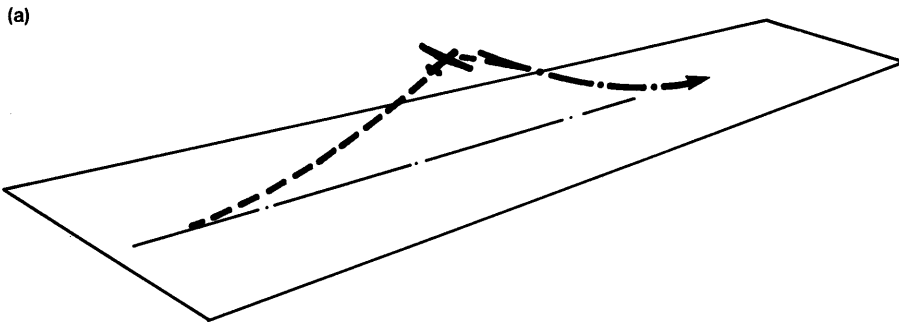

21 The easiest situation to deal with is the straight-ahead landing (a); when this is no longer possible because the glider is too far up the field then a turn to one side must be made. Having turned it may be possible to turn into wind and make a landing across the field (b). If unable to do this the pilot will turn again to make an abbreviated circuit or a 360° turn depending on the height available (c)

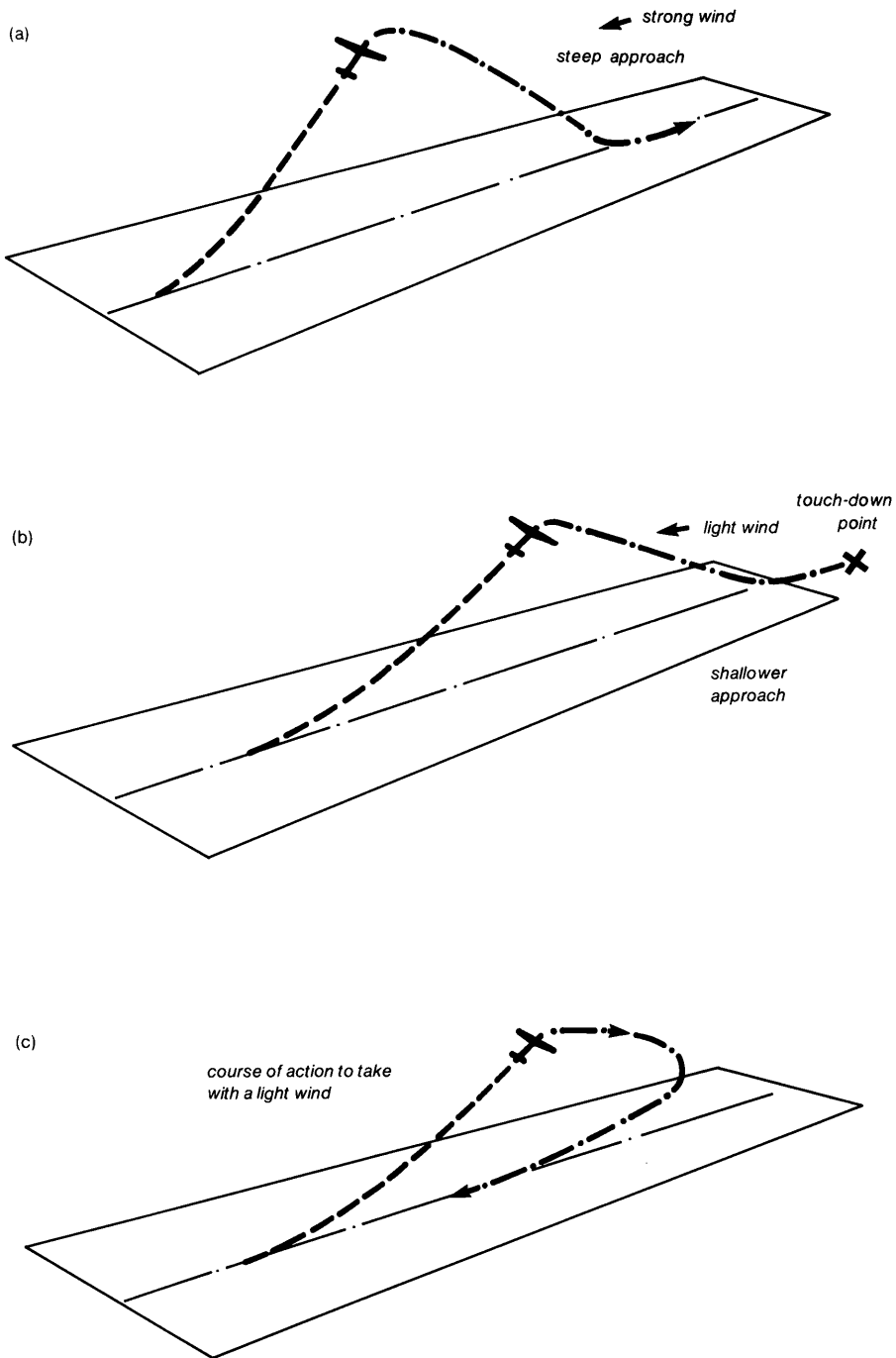

22 The effect of wind on straight-ahead landings following cable-breaks. The approach must be made at a safe airspeed, so whilst in a strong wind, the approach may be steep enough to allow a straight-ahead landing on the airfield, in a light wind the shallower approach will make this impossible. In this latter case, it may be best to land downwind. (Downwind landings cannot be made in higher winds because the ground speed would be too high.)

## The launch

the position of the glider in the airfield, the wind and even the airfield layout. To reinforce this point consider two launches, one in light wind and the other in a strong wind, the respective anticipated heights

being 700 ft and 1300 ft. (Figure 22)

Landing in the opposite direction to take-off is an option available to the pilot if the rope breaks on an aerotow launch or on a cable launch when winds are light.

*23 Cable breaks during aerotows may be dealt with in various ways, according to the height and position at which the break occurs. (a) landing straight ahead on the airfield; (b) landing straight ahead off the airfield; (c) landing downwind (in light winds only)*

(a)

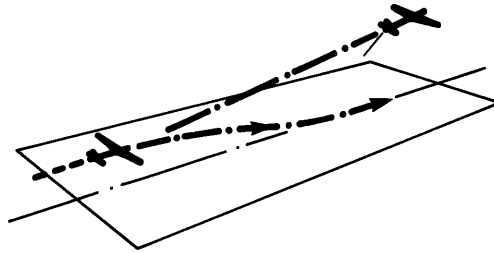

(b)

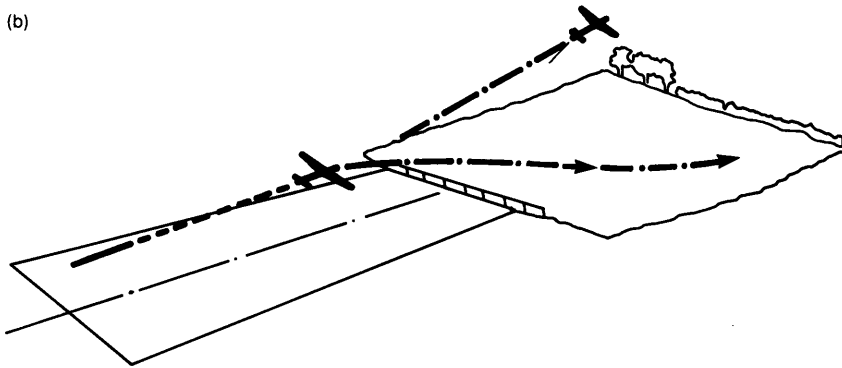

(c)

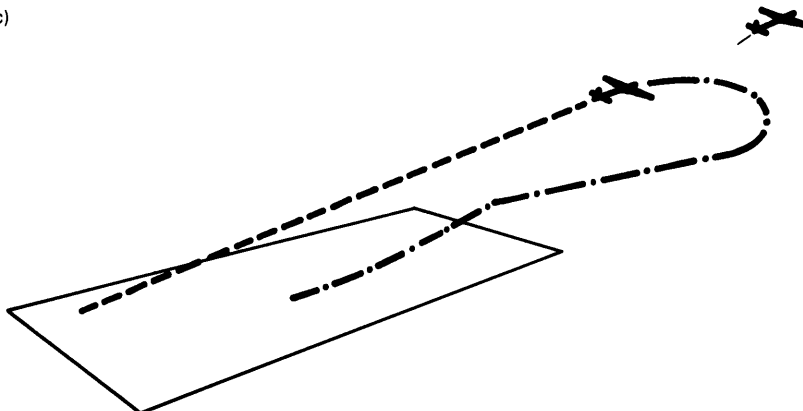

## Gliding and Soaring

In summary, the possible actions when a cable breaks are a landing straight ahead on the airfield, a landing in a field other than the airfield and a landing in the opposite direction to take-off. The latter is possible only in light winds because control of the glider on the ground is lost at a higher speed than in an into-wind landing.

All these situations can and do arise, and as a student you will be trained to cope with them. Each situation presents planning and judgement problems which are, in effect, variations of the circuit and approach exercise. The only difference is the time available, and although this may be limited acting hastily should be avoided.



## CHAPTER SIX

### **After solo : soaring and cross-country techniques**

The aim of flying solo has now been achieved and you can hold your head up, having joined an elite band of glider pilots. What comes next? Unfortunately, unlike a driving or a pilot's licence the certificate gained as a result of three solo flights, a 'B' certificate, does not mean that you will as a matter of course be sent solo again every time you come to glide. For the first solo flight, even though you might have dealt with more difficult conditions your instructor took certain precautions.

Now you have flown solo you will be much more confident and receptive to further instruction. Each day's flying should strike a balance between this instruction and further solo flying. The exercises in the two-seater will be the same as during basic training (i.e. up to solo standard), comprising recovery from stalls and spins, awkward situations in the circuit, dealing with launch failures and cable-breaks and landings in confined space. The final item is to refine your skill and judgement and is a preparation for landing in fields.

On the solo flights you should always have an aim: set yourself goals; a turn executed at exactly the right speed, a steeper turn, at 45° of bank and then

practise reversing the turn. All the time you should be working to improve your accuracy because this will affect the success you have in soaring. The immediate aim of the early solo pilot is to stay airborne for longer than he has done so far. The duration of training flights, and solo flights for that matter, will have been approximately one minute for every 200 ft of the launch height. For winch or auto-tow the time on the launch is relatively brief, nearly always less than one minute and frequently less than thirty seconds. An aerotow launch will take five minutes to 2000 ft and the total flight time of this type of launch will be fifteen minutes or so, unless you can soar. A good target is thirty minutes from a winch launch and a one-hour flight from an aerotow. A note of caution here: don't be tempted to stay airborne for too long at an early stage, rather gradually increase the duration. These flights can be quite tiring and inexperienced pilots are more likely to make errors of judgement when tired.

One of the temptations is to try for a five-hour flight, which is part of the requirements for the first international gliding award. Before attempting this flight, however, you should have at least two flights of two hours and perhaps one



## Gliding and Soaring

24 How the glider's rate of height loss is affected by the masses it is flying in. Height gain is achieved by flying through rising air

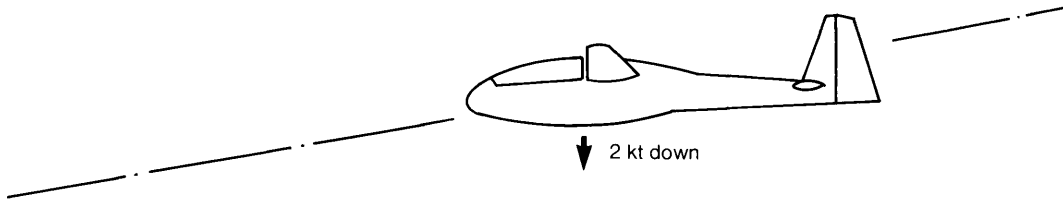

(a) The glider is descending through the air at 2 kt (200 ft/min)

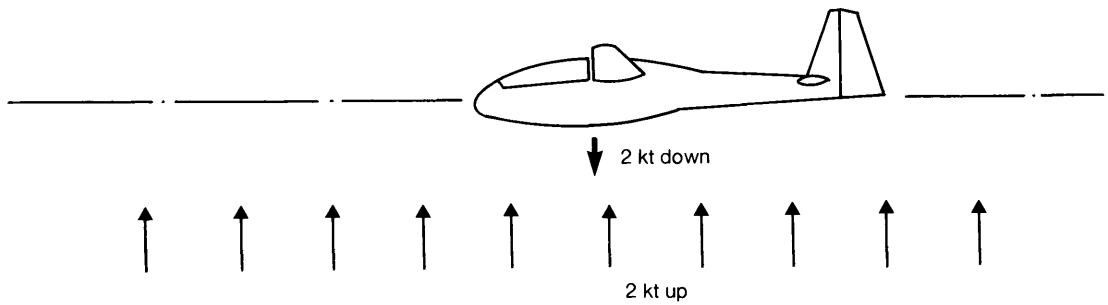

(b) If the glider is flown in a region where the air is rising at 2 kt then it will neither gain nor lose height

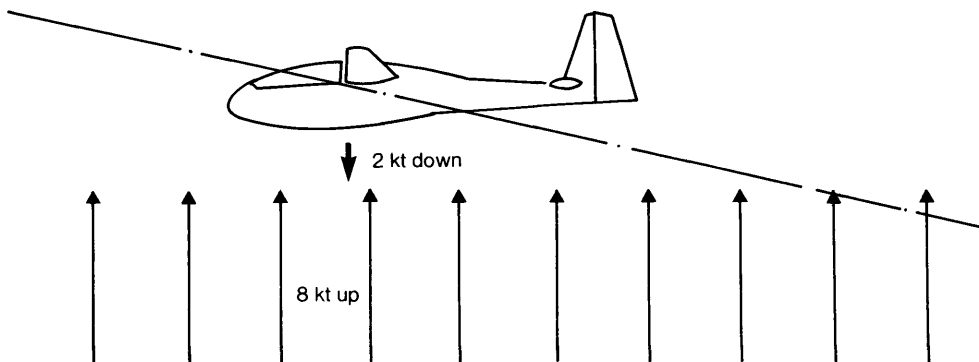

(c) If the air is rising at 8 kt then the glider will climb at 6 kt

of three or so. But how to achieve these flights? Rising air to carry the glider upwards is the obvious answer.

There are alternative sources of rising air. The basic requirement is that the air is rising at a greater rate than the glider is descending. Remember that the glider is always descending through the air. Only if the air in which the glider is flown is rising at a rate greater than the glider's descent rate will it climb. (Figure 24)

### **Hill, thermal and wave lift**

The first source of rising air to be used was where the wind was deflected upwards by a hill or ridge, the latter being better. Most of the long-established gliding clubs are situated on top of or at the foot of suitable ridges. The region of rising air, 'lift' to soaring pilots, is above and forward of the windward side of the ridge. The requirements for the lift to be there at all are that the wind is blowing almost at right-angles to the ridge and of certain strength, which for the lift to work depends on the height of the ridge – the smaller the ridge the stronger the wind must be. A ridge rising 250 ft above the general terrain may need a 20-kt wind to produce usable lift. A 1000 ft ridge may work in winds of 8–10 kt, but only to ridge-top height. The maximum height attainable in lift of this type is rarely more than two-and-a-half or three times the height of the ridge.

This lift source serves no other purpose than staying airborne unless the ridge, or range of ridges, is long enough to use for a cross-country flight. Using this type of lift requires some skill. The basic method is to fly to and fro along the front of the ridge, making turns away from it each time you change direction; turns are

always made into wind. It is essential to be aware of the possible hazards.

- 1 Behind, that is downwind of the region of lift, the air may be descending. Even if it isn't then it will be very turbulent and the glider may lose height rapidly.
- 2 If the glider is allowed to get behind the lift then to regain it, flying into wind with a low ground speed, may take longer than the height available allows.
- 3 Don't expect parts of the ridge not facing exactly into wind to produce good lift or even any lift.

There are some additions to the basic rules of the air for this form of soaring:

- 1 Turns are always made away from the hill or ridge.
- 2 To overtake another glider fly between it and the ridge.
- 3 Gliders approaching each other head-on should both alter course to the right. Of the two gliders in this situation while hill soaring, the one turning away from the ridge may have to take most or even all of the avoiding action.

Using this lift will take you only to a certain height. Having gained that height fly upwind and use it to practise and improve your skill or to look for other types of lift. You should return to the ridge lift by the time you are down to a particular height; this will usually be specified at the site from which you fly. The value given will certainly depend on whether you are landing on top of the hill or at the bottom of it. For landings 'on top' you will be discouraged from flying lower than 500 ft above the ridge, but for landings at the bottom you may continue to soar

## Gliding and Soaring

below hill-top height; how much will depend on the height of the hill.

The pioneers soon exhausted the potential of ridge soaring. By 1922 it was realised that there was rising air underneath cumulus clouds. Duration records were eventually abandoned in 1952. Cumulus clouds are those fluffy white cotton-wool clouds typical of many days from spring to autumn, and are, indeed, a consequence of the rising air. The process of cloud formation although not complicated does require a basic understanding of physics.

The source of energy for the earth and its atmosphere is the sun. The sun does not warm the air directly, the simple evidence for this being that the air gets colder the higher you climb. The air is warmed by the earth and the heat distributed through the atmosphere by a process called convection. It is interesting to note that the hottest days may have limited convection or none at all.

Heating of the earth's surface does not take place uniformly. Soaring pilots soon learn that cornfields, towns and hills, especially with the slope facing the sun, are better than wet or green surfaces at absorbing the sun's heat and passing it to the air in contact with it. Once the air has reached a certain temperature it breaks away from the surface and rises. If you can visualise this air which may eventually rise to form a cumulus cloud as a bubble elongating into a column and leaning over with the wind, this should give you a good idea of how the pilot will use this lift. He must circle.

Finding the lift is the first problem. If launched by winch the time and range to search is limited. There will be known 'good sources' around the airfield, one of

which will be the runways. However, as the bubbles of warm air, thermals as they are called, are intermittent from any one source there is an element of luck in making the initial contact. Have you been launched at the right time? If you have and you fly the glider into the thermal this will be marked by a tendency for the glider's nose to rise, a change in the sound in the cockpit and an increase in the air-speed. Last but not least will be the instrument indication. The instrument to indicate climbing or descending, the latter more often called sinking, is called a variometer. The only trouble with this instrument is that there is a delay, a lag, in its response, so all the other indications are useful. If the glider is flown straight for long then it will soon have flown through the lift and a turn should be made as the vario (for short) starts to indicate a climb. You may get a clue as to the best way to turn; if one wing tends to rise turn towards it, and don't forget the lookout!

Having started the turn use a moderate angle of bank ( $30^\circ$ ) and try to keep it constant, otherwise the circle will be irregular in shape. Stronger lift under one wing will tend to alter the angle of bank and flying into and out of lift will alter the speed. Keep both as constant as possible by maintaining the attitude. This is where that circling practice I talked about earlier really matters.

After a turn or two the vario readings will give an indication of where the best lift lies and the circle should be shifted in that direction by reducing the angle of bank at the appropriate point (it isn't essential to level the wings) for about three seconds – count 'one-and-two-and-three-and'. This moves the circle 200 ft or so. If the lift improves then

further shifts can be made until the strength is fairly consistent around the circle. This is called 'being centred'.

But wait! This sounds as though it might need a lot of concentration, and you're right, it does. You must not get so pre-occupied as to forget the lookout; other gliders may come and join you in the thermal. As you turn steadily around, one turn (360°) will be taking between twenty and twenty-five seconds, and you will need to be constantly aware of their position. Indeed there will be no chance to watch your instruments continuously; all that you will be able to do is glance at them every few seconds. Incidentally, there is another rule, a gliding rule of the air, that gliders sharing thermals all turn in the same direction. This is refined in practice, especially if the gliders are at a similar height, to try to keep on opposite sides of the circle. This means flying at similar speeds and bank angles. If you join another glider in a thermal then circle in the same direction as it does. If you lose sight of the other glider in this situation then ease out of the thermal until you locate him.

Once you are climbing in the thermal, especially if you have contacted it from a relatively low height after a winch launch, you will become aware that you are drifting with the wind and away from the airfield. How far is acceptable depends on the rate of climb, the strength of the wind and the performance of the glider (its glide angle). In a glider with a best angle of one in twenty-five it might be marginal to continue climbing at less than 2 kt (various all tend to read or be interpreted optimistically) in a wind of 15 kt.

The situation requires decisiveness. If the lift were abandoned then the glide

back towards the airfield would need to be at 48–50 kt (for typical club gliders) to make headway into wind.

Whether the lift is used depends on the climb rate, the wind strength and the glide angle when returning. It also depends on the height and position at which the lift was originally contacted. If due to over-concentration on the attempt to soar the glider has drifted out of gliding range, then an early decision to land in a field must be made. If there aren't any suitable fields then you have no right to be there in the first place.

It is quite likely that after one climb in a thermal you will not find another one and as you glide upwind towards the airfield you should make plans to land. If you are striving to stay airborne for an hour or more you will certainly need more lift. You might, however, achieve that aim by staying high underneath the cloud to which you climbed in the first instance. To develop the art of thermal soaring as it relates to cross-country flying you must be prepared to make glides from one thermal to the next. This will give you practice in choosing clouds: the ones with lift underneath are identifiable by their firm shape and flat bases. Decaying clouds are ragged and rarely have lift under them.

This climb, glide and choose-the-next-cloud sequence is the basis of cross-country flying. As your skill improves your technique should be refined to:

- 1 Reject lift which is weaker than expected, unless you are low.
- 2 Leave the lift if it deteriorates and recentring does not produce an improvement.

Later we shall see the use of this skill linked with navigation, field selection and

## Gliding and Soaring

field landing in a cross-country flight. Before that, however, there is another type of lift to consider.

Wave lift is found to the lee (downwind side) of high ground. Like thermal lift it requires certain meteorological conditions to be present, details of which are beyond the scope of this book. The lift is basically an extension of the hill-lift phenomenon. The air deflected upwards by the ridge descends again in the lee of it, and, if the atmospheric conditions are right, this continues as an oscillation, with alternate rising and descending air in a wave pattern. Unlike hill-lift, which extends only up to two or three times the height of the hill, wave-lift may extend up to ten times hill height. Heights of up to 30,000 ft are obtainable in the United Kingdom while the world record, set in America, is approximately 46,000 ft and looks set to stand for a long time.

The height at which this lift can be contacted varies considerably. Close to the lee of hills it may be possible to climb away from a few hundred feet above ground level (a.g.l.), but more often heights of 2000 to 3000 ft are necessary. Like contacting thermal lift there is some element of luck in being at the right place at the right time. As a 'stepping stone' to this type of lift it will be common to use hill-lift and sometimes thermals. Wave-lift is often present above the layer of thermal activity, i.e. the top of the cumulus clouds. The lift lies in bands across the wind and to soar in it the pilot must cause his glider to track (make good a path over the ground) at right-angles to the wind. This is not unlike soaring an imaginary ridge. Sometimes the pilot will have a good guide as to the position of the lift from long cigar-shaped clouds, called

lenticulars because they are lens shaped in cross-section. They do not move with the wind as they are continuously forming at the upwind edge and dissipating at the downwind edge.

The similarity to ridge soaring ceases as the wind gets stronger and the glider must be flown into wind to maintain its position in the wave (the situation is comparable to that shown in figure 13).

Winds of 60 to 70 kt may be anticipated at heights of 10 to 15,000 ft. Climbing silently above 10,000 ft is a beautiful, even euphoric, experience. The euphoria is likely to increase as you go higher due to lack of oxygen and one is ill-advised to go above 12,000 ft. without proper oxygen equipment. A particular problem of a lack of oxygen is that you are unable to detect the symptoms yourself. Although pilots have, on occasion, gone to heights of 18 to 20,000 ft without incident the risks in doing so are great. Combining with a lack of oxygen to debilitate the pilot further is the extreme cold, often below  $-20^{\circ}\text{C}$ , which requires special clothing.

A pilot soaring for height may need other skills if circumstances change in this high-flying environment. If conditions change the lift may cease and often the cloud closes into a complete layer. Now the pilot must be able to fly on instruments and maintain a course as he descends through the cloud. In addition he must be able to navigate without sight of the ground, known as 'dead reckoning' or D.R. The glider may accumulate ice in the cloud which spoils its performance, bringing it down more quickly and completely obscuring the pilot's view. A wise pilot will carry out such a descent with windows, known as direct-vision panels

(D.V.), open in spite of the cold.

The risk should be obvious: a pilot needs a lot of experience, many skills and a great awareness to fly safely in such conditions. The challenge of wave-flying extends to cross-country flight, the height alone being only an end in itself for international badge qualifications (see Chapter 8).

Each form of soaring relates to different types of flight. *Ridge soaring* is a convenient way to achieve duration flights, but beyond that only really serves as a 'stepping stone' to other types of lift; *Thermal soaring* is the principal means of going cross-country. Naturally, before a pilot goes across country he will gain a certain amount of experience in the

vicinity of his home airfield; *Wave soaring* is the principal means of going high, the alternative being flying in cumulus cloud or thunderstorms (called cumulonimbus). There are very few pilots who can be considered as experts in the art of wave cross-country flying. It is, perhaps, this aspect of the sport which offers the biggest challenge and scope for development.

Using the various forms of lift a pilot will strive first for duration, then height and distance, and finally speed. Speed is the essence of the sport at its most advanced, whether a pilot seeks to better his own fastest time over a particular distance, that of his fellow competitors in a contest, or a world record.

## CHAPTER SEVEN

# The first cross-country flight

There is nothing quite as thrilling as the first time you turn your back on the airfield to set course on a cross-country flight. You've waited for this moment; your skill as a soaring pilot will be adequate and you have proved your ability to land in a field, though this isn't your express aim on this flight because you have named another airfield as your destination, known as 'declaring a goal'. With regard to navigating you have discussed with your instructor the ground features that you will recognise easily and poured over the maps for hours.

In addition to this preparation a list of things to do is useful so that you don't forget anything in the excitement: the glider must be made ready and taken to the launch point. The trailer should be attached to the car, its lights and fittings for the glider checked and a driver briefed (make sure you leave him the keys). The stories you will hear around gliding clubs are legend and include funny-in-retrospect examples such as going two hundred miles in the wrong direction due to confusion over place names and arriving to collect a glider from a field only to find one inside the trailer already.

In the glider's cockpit you will need a map, folded if possible to show the whole

of the proposed route and a line drawn on it to your destination. This may not always be straight because of the need to fly around controlled airspace in the vicinity of major airports. (The subject of controlled airspace almost merits a book on its own. It is every pilot's responsibility to know the relevant rules before flying cross-country.) Other bits-and-pieces include warm clothing, money for the telephone to report the landing position, and the barograph (see Chapter 8). Make sure it's switched on.

'Tie-down' equipment is desirable in case you have to leave the glider unattended. If it's very warm it pays to have a hat to protect you from the sun and sensible shoes rather than sandals since you may have some distance to walk.

For a first cross-country flight it's best to wait until the soaring conditions are really good before launching. If it takes some time to find the lift or you have been winch-launched (limited time to contact the lift) try not to be too discouraged if it takes you some time to settle down.

A balance of three basic skills is required for the success of this flight: the ability to soar, to navigate and to choose a field and land in it, though if you reach your goal this last one won't be necessary.

## The first cross-country flight

### Soaring technique

The change in technique from soaring in thermals in the area immediately around the home airfield to that required for a cross-country flight is not great. Having gained height in the first thermal, set off to a likely looking cloud as nearly on track

as possible. Be prepared, however, to deviate from track at any time if conditions along it look bad. Unsuitable conditions include large areas where the clouds have cut off the sunlight from the ground (called cloud shadow), areas where there are no cumulus clouds when clouds exist elsewhere, and rainshowers.

25 A typical cross-country flight in diagrammatic form. In this representation of a cross-country flight the glider got too low – about 1500 ft a.g.l. By this stage the pilot should be as concerned with the selection of a suitable field as he is with soaring.

The pilot flew south of track due to the

large area of cloud shadow. There was a limit to how far he could go due to the controlled airspace which was of a category in which gliders are not allowed to fly. Nearer the destination are some arcs of circles showing the height from which a final glide can be made

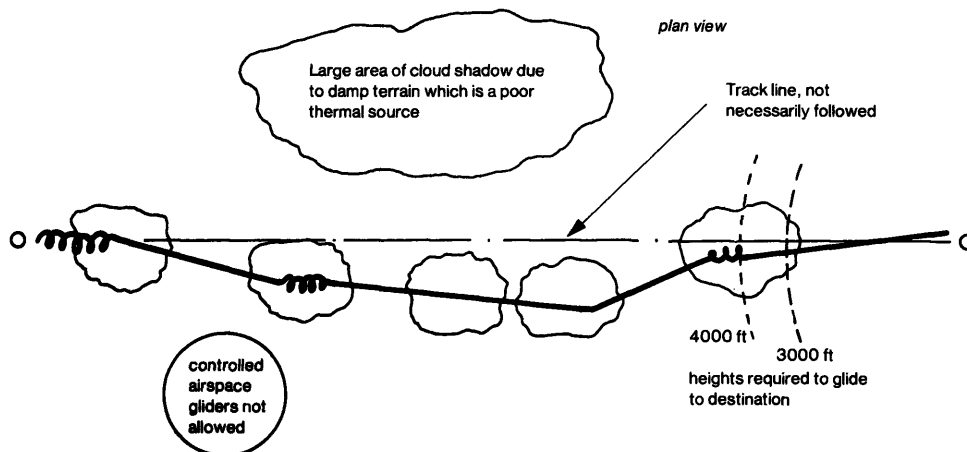
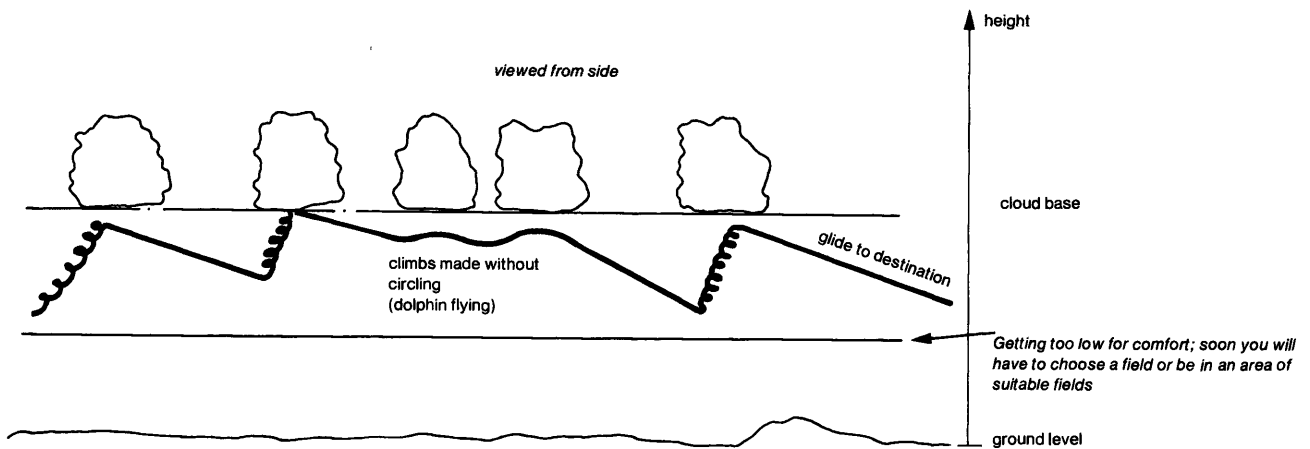



## Gliding and Soaring

Adequate height for setting course will vary from place to place (in some areas the clouds tend to be lower than in others) but 3000 ft is the minimum recommended and 4000 ft is better. The reason for having this much height is that it removes the immediate likelihood of having to land; below 2000 ft you will become pre-occupied with choosing an area with fields suitable for landing to the detriment of your concentration on soaring.

Having set course, a straight glide in which the glider loses a thousand feet or so will take it approximately five miles,

further with the wind behind you. The height loss of 1000 ft is arbitrary. In practice you might lose 700 to 1500 ft before the next lift is encountered. What must be discouraged is using more lift after a height-loss of only 200–300 ft, as this will result in a low cross-country speed. Flying in this way, climb and then glide, will make the flight much more purposeful than staying high, using all the lift available and drifting with the wind. One of the troubles with the latter technique is that the pilot might not reach his destination simply because height is lost

*26 The final glide will start several miles out, and the pilot flies across the finish line at speeds up to 120 knots. The two trails of 'smoke' from the wings are, in fact, water which is being jettisoned prior to landing. Water is carried to increase the speed at which the glider achieves its best performance. It is detrimental to the performance whilst circling but the modern glider is so efficient that it may often not be necessary to stop and circle in the lift but simply to fly slowly through it. This technique is called 'dolphin flying'*



## The first cross-country flight

searching for more lift when already within gliding range. If the glider will go approximately five miles for every thousand feet height-loss then a climb to 4000 ft ten or fifteen miles from the 'goal' will be enough to get you there. A purposeful style of flying will achieve the best results. This positive approach is essential when later you are trying to complete bigger cross-country flights. Figure 25 shows a typical first or early cross-country flight in diagrammatic form.

On early flights, the final glide must make a generous allowance of height to make a circuit and the pilot must remind himself that his altimeter doesn't show his height above *this* airfield; in practice altimeters are usually set to read heights above sea level for a cross-country flight). Final gliding of the kind shown in figure 26 is seen at the completion of speed tasks and competition flights.

### **Navigation**

The progress of a glider over the ground is not consistent, stopping as it does to circle and gain height. A computation of the distance covered on an elapsed time/speed basis is not as easy as in an aeroplane but a record should be kept of the time that a feature on the ground is recognised. This will prove useful if in a period when soaring is difficult the navigation is neglected.

On setting course from the top of the first thermal you will probably steer for some feature which is on track and already within view (known to you from soaring the local area). Note the compass reading because later in the flight, without any

known landmarks, you will be glad of this information. An additional reference that will help keep you orientated is the sun: remember that its position changes by 15° every hour.

Don't expect to stay exactly on track. Divert to good-looking clouds or to avoid large areas of cloud shadow. Try to keep some awareness of time to give a first approximation to average speed. Once past the local landmarks you will have to look for unfamiliar ones, some of which may be difficult to see from a long way off. This is when the awareness of time is important. If it has taken twenty-five minutes for the first ten miles then your estimate for the next ten is another twenty-five. In particular, don't look for a landmark you can't possibly see. Railways, canals and motorways are in this category. All of these are line features and will be visible only from a mile or two away unless your track lies exactly in line with them. A line feature lying across the track will tell you only the distance flown. An additional feature is needed to confirm where along its length you are crossing. Always check the angle at which you cross and the compass reading as you do so.

Many other features will prove useful but towns and airfields should always be confirmed by additional features such as roads, water, railways etc. While doing so the map should be orientated with the track, that is, look at the map in the same direction as you see the ground. There are many pitfalls in navigating and being aware of them is the only protection against getting lost until you have gained some experience.

Some of these pitfalls are given over-leaf:

## Gliding and Soaring

- 1 Don't try to see a landmark before it is possible to do so, e.g. a railway in a cutting. Such landmarks will be visible only when you are a mile or two from them. Estimate the time to reach them.
- 2 Roads are unreliable as features; different grades of road look much the same. The exception (in the U.K.) are Roman roads (very straight) and motorways. Check for bridges over motorways so as not to confuse them with dual carriageways.
- 3 Use a half-million map (scale 1 : 500,000, or approximately 8 miles to one inch), and make sure it is up-to-date. The larger scale maps show too much detail and will tempt you to do too much navigating.
- 4 Some features such as lakes, clearly visible from the air, may be too small to be shown on the half-million map.
- 5 Beware convincing yourself that you are lost if a feature suddenly appears which isn't on the map. Check time, heading, and wait for the next one to show.
- 6 Don't try to navigate while thermalling.
- 7 Remember that a landmark can still be useful when you have flown past it.
- 8 Don't 'home' on the first thing you see that resembles the next feature without first checking your heading. Remember you may only be able to see the corroborative evidence from nearly overhead.

Should you fail to soar on a cross-country flight and there is not a suitable airfield within gliding range then a field landing becomes necessary.

### ***Field selection and landing***

Below about 1500 ft above ground level, the inexperienced pilot, while not abandoning attempts to soar, should aim to be near an area of suitable fields. Be aware that over-concentration on soaring at this height may mean drifting away over less suitable terrain.

The first thing you look for is a field of adequate size and suitable surface. Size is relative of course: a medium-size field may look large if all the fields around are small but instructors will generally avoid sending their students towards regions of small fields. The surface presents a problem. What looks like grass from 1500 ft may prove to be unripened cereal crops as one gets lower. The order of preference varies throughout the season but cut cereal crops or hay-fields are best, with grass a poor second. Pastures may have cattle or sheep and are frequently divided by electric fences, which are difficult to see from the air. Really good fields are few and far between so make a habit of studying them at every available opportunity and improving your ability to select them.

Throughout the flight you should have tried to have an awareness of the wind direction because now this becomes important. At 1000 ft ideally there will be a choice of one or two fields of adequate size, suitable surface and level. If the field slopes then it's essential to make an uphill landing even if this is downwind. An assessment of slope is best gained by

## The first cross-country flight

looking at the locality as a whole rather than the field itself. If the slope is obvious from 1500 ft or above then it's likely to be too steep for landing without the risk of the glider rolling backwards.

Below a thousand feet some other features become apparent. Of these in particular, telephone wires, power wires, any wires on poles in fact, are a hazard. First of all they are difficult to see (in checking look for the poles not the wires) and second if you have to approach over them they effectively shorten the field's length. Roads nearly always have wires along their edges. Avoid choosing a field adjacent to a road if the approach has to be made over it.

The other potential hazard revealed as the glider gets lower is that the crop in the field may not be what you thought: green cereal crops may have been mistaken for grass. The glider may be damaged by landings in such fields. However, it may be better to accept that risk rather than make a last-minute re-selection and a hurried

approach. A maxim to suit this circumstance is 'that a good approach into a bad field is better than a bad approach into a good one'.

The landing in a field is not in itself difficult, but planning the circuit needs an awareness of the differences between it and the circuit at your home airfield, that is that the familiar landmarks are missing. If you are not conscious of this fact you will tend to relate to the boundaries of the actual field in which you intend to land. The circuit should be started three or four fields upwind of the one in which you intend to land and a couple of field lengths to one side. The base leg will be positioned one or two fields back from it, depending, of course, on the wind strength. To get an idea of this check how many fields you fly over in making a circuit at your club's airfield. Bear in mind, too, that a landing along the diagonal of a field means more room, which is doubly advantageous if the diagonal happens to be into wind.

## CHAPTER EIGHT

# Achievements

Gliding is a complex and technical sport, so that the printed word cannot substitute for experience and direct teaching by your instructor. But in telling you the fundamentals, and providing a broad basis for your instruction, this book would not be complete without a guide to your future goals: there are recognised achievements at both national and international levels. They are laid down as a series of qualifying flights, on completion of which the pilot is awarded a certificate and badge. The national level awards vary slightly between different countries.

### ***National certificates***

**First solo:** In spite of the sense of achievement you will feel, a solitary solo flight no longer merits an award. At one time there was an 'A' badge for this flight, a blue badge with a single gull motif on it. It was appropriate to the training system in the 1930s when the first solo flight would usually be flown in a straight line.

**The 'B' badge:** This badge has two gull motifs in it and is awarded when the pilot has made three solo flights, usually done in succession, and demonstrated his or her ability to take off and land and turn in either direction.

**The 'C' badge:** This badge marks the first step to becoming a soaring pilot and is awarded after the first soaring flight. The requirements vary a little from country to country but in the United Kingdom the pilot has to stay above the height to which he was launched for five minutes, which means at least a 15-minute flight from a winch-launch. You do not have to attempt this badge, or any of the others for that matter, and most pilots try directly for the bronze 'C'.

**The Bronze 'C':** This is the final step towards the first of the international badges, and is an award unique to the United Kingdom. It corresponds approximately to the requirements for the glider pilot's licence, which is mandatory in many countries.

There are various tests and achievements that a pilot must complete in order to qualify:

- 1 Two soaring flights, each at least thirty minutes when launched by car, winch or bungee (a catapult launch from a hill top), or sixty minutes after release from an aerotow to a height not exceeding 2000 ft. Landings must be normal and within the boundary of the airfield. The candidate must be alone in the aircraft for each flight.

- 2 A minimum of two flights in a dual-controlled glider with an instructor who must satisfy himself that the candidate is proficient in the following exercises:
  - a) Well co-ordinated and accurate general flying, especially the keeping of a good lookout.
  - b) Understanding and recognition of the stall, incipient spin and full spin, followed by the correct recovery.
  - c) Two landings into a field or into a marked area of the airfield without using the altimeter: these may be done solo if a suitable two-seat glider is not available.
- 3 The candidate must take an examination (multiple choice questions) in Navigation and Airmanship, Meteorology, Principles of Flight and Air Law. The pass mark is 70% except for the air law paper in which 90% is needed.

The badge was introduced to provide a step between the humble 'C' badge and the seemingly unattainable silver 'C', the first of the international badges.

The international badges are awarded by the Aero Club of each country, who are authorised by the Federation Aéronautique Internationale (F.A.I.) in Paris.

### ***The international badges***

**The Silver 'C'**: There are three separate achievements to gain this badge; distance, height and duration. Most pilots attempt the duration first, a flight of five hours. There is much argument among pilots about the value of such a test and as much again about the way in which it's done. A five-hour flight in thermals almost certainly requires a higher degree of skill than

the same flight on a ridge. The sheer monotony of the ridge flight makes it more a test of concentration and endurance. Perhaps the best way to achieve the duration is while completing the cross-country flight. Not that the distance of 50 km ever takes five hours. However, an hour's soaring at your base airfield followed by two hours of cross-country flying and a further two hours of local soaring at the destination is the most interesting way to achieve two parts of the badge.

The distance flight of 50 km, a nominal distance in a modern glider, is usually nowadays completed to a pre-declared goal, another gliding site or airfield. Although the flight is not required by the test to be to a pre-declared goal, setting oneself this demand makes the flight more exacting and fulfilling.

Incidentally, if you think there's any easy way to achieve this flight by taking a high launch and gliding downwind then you'd be wrong. The height-loss from the point of release from the launch to the landing must not exceed one per cent of the distance covered. If take-off and destination airfields are at the same height then the maximum launch height is 500 m (1640 ft). If you took a launch to 2500 ft then the distance would have to be 76.2 km. To avoid getting caught in this trap you need to do some sums before take-off.

The final qualification is a gain of height of 1000 m. This is 3280 ft, and if you add a margin of 200 ft or so then it can be a problem in some places; either if the airfield is high (above sea level) or the cloud base is unusually low.

For all these tests the glider must have a

## Gliding and Soaring

height-recording device called a barograph. This is a paper-covered clockwork-driven drum, which rotates once in ten hours. Marking the drum, to indicate the heights, is a needle connected to a pressure-sensitive mechanism. Since pressure decreases as you go higher, your height can be determined from the barograph record. The mechanism is calibrated annually or whenever there is a marginal claim. The trace for a typical good height-gain flight is shown in the figure.

The barograph trace will indicate that the glider was not landed at any intermediate stage of a cross-country flight and may also be used to check the duration of a flight by calibrating the rotation rate of the drum.

In summary, the requirements for a silver 'C' are:

- a) duration; a flight of five hours.
- b) distance: 50 km, unless the height-loss is more than one per cent of the distance covered.
- c) height gain: 1000 metres.

All the parts can be completed on the one flight.

Although the gap between the 'C' certificate and the silver 'C' seem considerable the step to the next badge may seem enormous.

**The Gold 'C':** There are three requirements for this qualification:

- a) duration: (five hours); the silver 'C' flight will count.
- b) Height gain: 3000 m (9841 ft).
- c) Distance: 300 km.

If you go to the right place, a wave site, the height gain may not prove too difficult. The distance of 300 km (186.42 st. miles), however, represents a big step. The distance may be done in a straight line but rarely is nowadays. Apart from economic

reasons, it entails a lot of driving to retrieve the glider; by covering the distance around a pre-declared course you can have it count towards the next award, the diamond badge. To achieve this the distance must be completed around either a triangular course or as an out-and-return, that is to a point at least 150 km from the starting point and back. Either way the pilot must bring back photographic evidence of having rounded (flown beyond) the turning points. The film, which must be given to the observer uncut, will have evidence of the starting and finishing points, usually a photograph of the glider with witness in the picture or of the declaration board, a blackboard with the proposed task written on it. There must also be a barograph trace.

The successful completion of this task will entitle the holder of a gold badge (assuming he has done the height-gain already) to wear one diamond on it. Other diamonds can be added for further bigger tasks.

### The diamond badge

The three diamonds are:

- a) A 300 km, goal flight (to a declared destination) around a triangular or out-and-return course.
- b) Distance of 500 km (310.7 miles), which may be in a straight line but which is more often completed as a closed-circuit goal flight
- c) Height gain of 5000 m (16,404 ft).

I don't propose to dwell on these flights, but to give you an idea of the relative rarity of the badge there are only 76 holders of it in the United Kingdom – and 10,000 people glide!

### ***Beyond the badges***

Gliding, or rather soaring, has advanced at a considerable rate in the last decade, to such an extent that the F.A.I. now award

diplomas to pilots who have completed a distance of 1000 km or more. Apart from this, of course, there are competitions at various levels, regional, national and international.

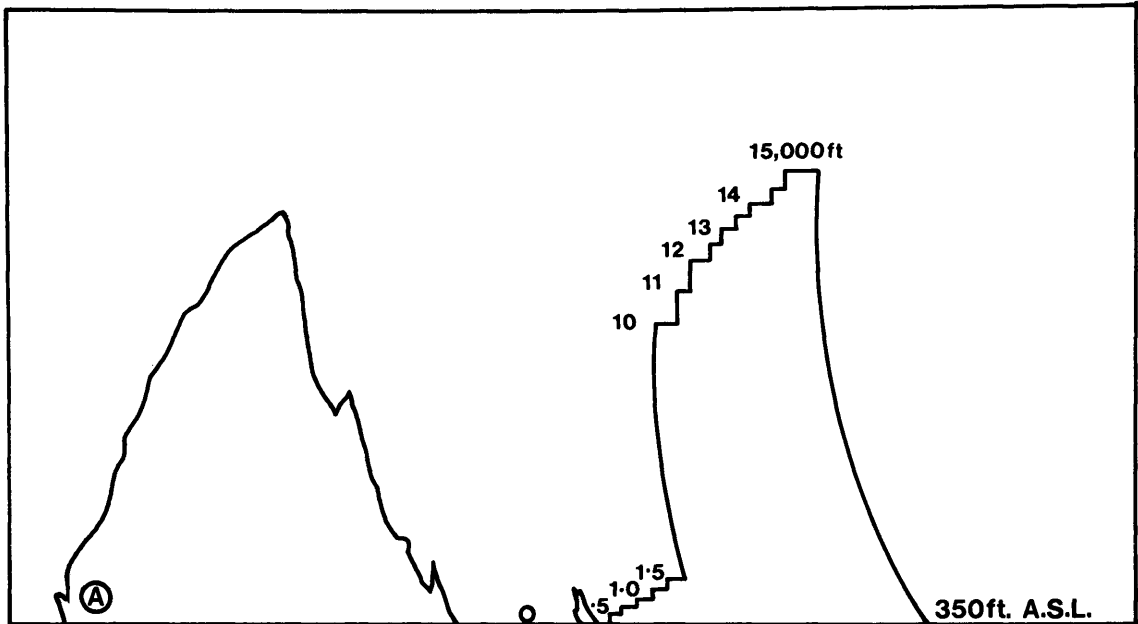

*27 Barograph trace for a high flight and the calibration. The flight was from a winch launch to 900 ft. Immediately after the launch the glider was flown into ridge lift. Once it was established that the ridge was working a dive was made to mark the trace with a 'low point'. (A) It is essential not to go straight into the climb from the launch, so that the person certifying the flight can see clearly where the one ended and the other began. The climb was continued in wave lift to 14,000 ft. The calibration was completed immediately after the flight*



## Appendix : The Development of Gliders

1 *The old glider in the background is a Gull 1. In contrast, the modern Italian sailplane the Calif is sleek and streamlined. Made from metal, it can achieve considerable distances at high speed in the hands of a competent pilot*



## Glider development



2 This glider, a Tutor, was built by the British firm of Slingsby Sailplanes, the prototype first flying in 1937. Obviously a very basic glider with its wing struts and open cockpit, it has a glide angle of one in eighteen

3 The Slingsby Sky. First flying in 1950, this aircraft won the world championship in 1952, piloted by Philip Wills, in Spain



## Appendix



4 *The Eon 460/463 is a 1960 design by Elliotts of Newbury, of wooden construction. In its day a high performance glider with a best glide angle of about one in thirty, it would today be classed as intermediate*

5 *The Dart 17: the last of the British-built wooden gliders, it first flew in 1963. With a glide angle of one in thirty-three, it might not seem a great improvement over its predecessors, but it was particularly good at maintaining a good glide angle at high speeds*





*6 The Libelle. A new era of glider construction began when glass-reinforced plastics, more commonly called fibreglass, were introduced. The advantage of these materials is the high standard of surface finish which can be achieved. This Libelle has a span of fifteen metres and a best glide angle of one in thirty-eight*



*7 The Kestrel 19. Striving for improved performance resulted in gliders of greater wing span. This Kestrel 19 (of nineteen metres wing span) is a British development of the German Kestrel 17, built under licence in the U.K. It has a one in forty-four glide angle*

## Appendix



*8 The Schleicher ASK 16. The concept of a self-launching glider, a motor-glider, has exercised the minds of designers for forty years. This one, which resembles an aeroplane except for its long slender wings, has a glide angle of one in twenty-five when its wheels are retracted and its propeller feathered. A motor-glider is particularly useful for training in the circuit; and since lost height can easily be regained, much more use can be made of a single launching. 'ASK 16' represents the sixteenth design of Kaiser, built by Alexander Schleicher*



*9 The ASK 18 is a fairly recent design, and by virtue of its easy handling is suitable for early solo pilots. It has a performance good enough for long cross-country flights. With wings made of wood and a fuselage of steel tube, it is very robust, and an ideal club glider*



## Glossary

**aileron** : the control surface at the trailing edge of each wing, extending inwards from the tip for about 30% of the wing's length, which causes the aircraft to roll (bank). When the control column is moved to the left, the left aileron goes upwards, the right down, and the aircraft banks to the left.

**airbrakes** : vertical surfaces, four or five feet in length, which extended above and usually below the wing. They are used to control the rate of descent in the approach by increasing the drag. In order to maintain airspeed, the nose has to be lowered, which has the advantage of allowing a better view of the landing area.

**aircraft movements** : an aircraft can move in three senses :

- 1 Pitching is the term applied to up or down movements of the nose, controlled by the elevator.
- 2 Rolling is the movement controlled by the ailerons. A glider is rolled to achieve a particular angle of bank.
- 3 Yawing is the term applied to a swinging movement of the nose.

**attitude** : strictly, the position of the aircraft relative to the ground, but the term is generally used to refer to the view seen by the pilot of the relationship between the nose of the glider and the horizon. Speed is controlled by changing the attitude by means of the elevator

**bank** : see aircraft movements

**brakes** : see airbrakes

**circuit** : the pattern flown by a glider around a landing area before touch-down. See figure 14.

**controlled airspace** : the areas (which are marked on air maps), near airports, military airfields, and other areas with much traffic, where rules restrict an aircraft's movement, and radio contact is required. There are restrictions on gliders entering some controlled airspace

**D.I.** : the daily inspection. See page 10

**drag** : the resistance to motion through the air

**elevator** : the rear-most control surface, attached to the tailplane, which controls pitching

**glide angle** : the amount a glider descends for a given distance moved forward : a glide angle of one in forty, for example, means that the glider can glide forty miles from a height of one mile (5280 feet)

**hill-lift** : the rising air produced when a hill facing into wind deflects the air current upwards

**pitch** : see aircraft movements

**rudder** : the control surface attached to the fin, which controls yaw

**roll** : see attitude changes

**soaring** : making use of rising air to maintain or gain height.

There are three kinds :

- 1 ridge : a convenient way to achieve duration flights, using hill-lift. Hill-lift may be used as a stepping-stone to other types of lift.
- 2 thermal soaring : using the up-currents resulting from differential heating of the earth's surface

- 3 wave soaring : using the waves which result from air deflection by hills or mountains. Principal means of going high. Another means of achieving height is to use the rising air in cumulo-nimbus clouds

**trim** : the 'bias' applied to the control surfaces to remove residual forces. Once a desired attitude has been achieved, the trim is adjusted so that the force on the control is balanced. This is done by a small extra surface on the elevator called the trim tab. It keeps its position once set, unlike the main control surfaces

**yaw** : see aircraft movements



## Further Reading

### Theory

*Principles of Flight* (loose-leaf lecture notes) – W. G. Scull – B.G.A., 1969

*Theory of Flight for Glider Pilots* – R. C. Stafford Allen – Oliver and Boyd, 1969 (2nd revised edition)

(advanced) *New Soaring Pilot* – A. Welch et al. – John Murray, 1968 (2nd rev. ed.)

### Practice

*Beginning Gliding* – Derek Piggott – A. & C. Black, 1975 (pp 208)

*Gliding: a handbook on Soaring Flight* – Derek Piggott – A. & C. Black, 1971 (3rd rev. ed.)

### Weather

*Beginners Guide to Weather Forecasting* – S. Wells – Pelham Books, 1975

*The Weather Guide* – A. G. Forsdyke – Hamlyn, 1969

(advanced) *Meteorology for Glider Pilots* – C. E. Wallington – John Murray, 1966

### General

*Laws and Rules for Glider Pilots* – compiled by A. Welch – B.G.A.

B.G.A. publications are produced by the British Gliding Association, Kimberley House, Leicester, from whom a list of books on the subject can be obtained.

# Bill Scull:

## Gliding and Soaring

Gliding presents those who take up its challenge with ever-widening horizons. The sheer beauty of the countryside viewed in silence from several thousand feet is, even in these days of air travel, the privilege of only a few.

Learning to glide requires instruction in the air, but ground instruction is equally important. The pilot must understand the principles before he can make the best use of his time in the air.

In *Gliding and Soaring*, Bill Scull provides a complete basis for learning the skills and judgement required for flight without power. His book is complementary to practical instruction, ranging from how to start, to advanced cross-country flying techniques.

Bill Scull became a club instructor seventeen years ago; he is now the Senior National Coach for the British Gliding Association. He has taught both beginners and expert pilots, and knows both the difficulties the beginner will meet, and the challenge of advanced soaring.

### OTHER TITLES IN THIS SERIES

WOMEN'S LACROSSE	Celia Brackenridge	ISBN 0 7207 0929 6
ATHLETICS-JUMPING AND VAULTING	Denis Watts	ISBN 0 7207 0919 9
ATHLETICS-THROWING	Howard and Rosemary Payne	ISBN 0 7207 0925 3
JUDO	Brian Jacks	ISBN 0 7207 0922 9
SQUASH RACKETS	Richard Hawkey	ISBN 0 7207 0799 4
CRICKET	Barry Richards	ISBN 0 7207 0815 X
RUGBY UNION	John Dawes	ISBN 0 7207 0792 7
TABLE TENNIS	Chester Barnes	ISBN 0 7207 0791 9
SOCCER	Bob Wilson	ISBN 0 7207 0793 5
BOXING	Henry Cooper	ISBN 0 7207 0790 0
GOLF	Ken Adwick	ISBN 0 7207 0852 4
UNDERSTANDING BILLIARDS AND SNOOKER	Jack Karnehm	ISBN 0 7207 0860 5
WOMEN'S HOCKEY	Rachael Heyhoe Flint	ISBN 0 7207 0806 0
BADMINTON	Paul and Sue Whetnall	ISBN 0 7207 0867 2
SWIMMING	David Haller	ISBN 0 7207 0954 7